



RCA VICTOR



Model 630TS
Walnut or Mahogany

TELEVISION RECEIVER MODEL 630TS

Chassis No. KCS 20A (60 cycles) and
KCS 20C-2 (50 cycles)—Mfr. No. 274

SERVICE DATA

—1946 No. T1—

RADIO CORPORATION OF AMERICA
RCA VICTOR DIVISION
CAMDEN, N. J., U. S. A.

GENERAL DESCRIPTION

Model 630TS is a thirty-tube, direct-viewing, 10" table model, Television Receiver. The receiver is complete in one unit and is operated by the use of seven front-panel controls. Features of the receiver include: Full thirteen channel coverage; F-M sound system; Improved picture brilliance; A-F-C horizontal

hold; Stabilized vertical hold; Two stages of video amplification; Noise saturation circuits; Three stage sync separator and clipper; Four mc. band width for picture channel, and Reduced hazard high voltage supply.

ELECTRICAL AND MECHANICAL SPECIFICATIONS

PICTURE SIZE 6 $\frac{3}{8}$ " x 8 $\frac{1}{2}$ "—2" radius at corner

R-F FREQUENCY RANGES

Channel Number	Channel Freq. Mc.	Picture Carrier Freq. Mc.	Sound Carrier Freq. Mc.	Receiver R-F Osc. Freq. Mc.
1	44.50	45.25	49.75	71
2	54.60	55.25	59.75	81
3	60.66	61.25	65.75	87
4	66.72	67.25	71.75	93
5	76.82	77.25	81.75	103
6	82.88	83.25	87.75	109
7	174-180	175.25	179.75	201
8	180-186	181.25	185.75	207
9	186-192	187.25	191.75	213
10	192-198	193.25	197.75	219
11	198-204	199.25	203.75	225
12	204-210	205.25	209.75	231
13	210-216	211.25	215.75	237

FINE TUNING RANGE

Plus and minus approximately 300 kc on channel 1, and plus and minus approximately 750 kc on channel 13.

POWER SUPPLY RATING

KCS 20A 115 volts, 60 cycles, 320 watts
KCS 20C-2 115 volts, 50 cycles, 320 watts

AUDIO POWER OUTPUT RATING

Undistorted 2.5 watts
Maximum 4 watts

LOUDSPEAKER (970121-1)

Type 5 inch Electro Magnet Dynamic
Voice Coil Impedance 3.2 ohms at 400 cycles

WEIGHT

Chassis with Tubes in Cabinet 85 lbs.
Shipping Weight 98 lbs.

RECEIVER ANTENNA INPUT IMPEDANCE 300 ohms balanced

DIMENSIONS (inches)	Length	Height	Depth
Cabinet (Outside)	26	14 $\frac{1}{2}$	19
Chassis Base (Outside)	19 $\frac{1}{4}$	3 $\frac{3}{4}$	15 $\frac{1}{2}$
Chassis Overall	21 $\frac{3}{4}$	11 $\frac{3}{4}$	16 $\frac{1}{8}$

RCA TUBE COMPLEMENT

Tube Used	Function
(1) RCA 6J6	R-F Amplifier
(2) RCA 6J6	R-F Oscillator
(3) RCA 6J6	Converter
(4) RCA 6BA6	1st Sound I-F Amplifier
(5) RCA 6BA6	2nd Sound I-F Amplifier
(6) RCA 6AU6	3rd Sound I-F Amplifier
(7) RCA 6AL5	Sound Discriminator
(8) RCA 6AT6	1st Audio Amplifier
(9) RCA 6K6GT	Audio Output
(10) RCA 6AG5	1st Picture I-F Amplifier
(11) RCA 6AG5	2nd Picture I-F Amplifier
(12) RCA 6AG5	3rd Picture I-F Amplifier
(13) RCA 6AG5	4th Picture I-F Amplifier
(14) RCA 6AL5	Picture 2nd Detector and D-C Restorer
(15) RCA 6AU6	1st Video Amplifier
(16) RCA 6K6GT	2nd Video Amplifier
(17) RCA 6SK7	1st Sync Amplifier
(18) RCA 6SH7	Sync Separator
(19) RCA 6SN7GT	2nd Sync Amplifier and Horizontal Discharge
(20) RCA 6J5	Vertical Sweep Oscillator and Discharge
(21) RCA 6K6GT	Vertical Sweep Output
(22) RCA 6AL5	Horizontal Sync Discriminator
(23) RCA 6K6GT	Horizontal Sweep Oscillator
(24) RCA 6AC7	Horizontal Sweep Oscillator Control
(25) RCA 6BG6G	Horizontal Sweep Output
(26) RCA 5V4G	Horizontal Reaction Scanning
(27) RCA 1B3-GT/8016	High Voltage Rectifier
(28) RCA 5U4G	Power Supply Rectifiers (2 tubes)
(29) RCA 10BP4	Kinescope

Specifications continued on page 2

630TS

ELECTRICAL AND MECHANICAL SPECIFICATIONS (Continued)

PICTURE I-F FREQUENCIES

Picture Carrier Frequency	25.75 Mc.
Adjacent Channel Sound Trap	27.25 Mc.
Accompanying Sound Traps	21.25 Mc.
Adjacent Channel Picture Carrier Trap	19.75 Mc.

SOUND I-F FREQUENCIES

Sound Carrier Frequency	21.25 Mc.
Sound Discriminator Band Width (between peaks)	350 kc

VIDEO RESPONSE To 4 Mc.

FOCUS Magnetic

SWEEP DEFLECTION Magnetic

SCANNING Interlaced, 525 line

HORIZONTAL SCANNING FREQUENCY 15,750 cps

VERTICAL SCANNING FREQUENCY 60 cps

FRAME FREQUENCY (Picture Repetition Rate) 30 cps

OPERATING CONTROLS (front panel)

Channel Selector	}	Dual Control Knobs
Fine Tuning		

Picture	}	Dual Control Knobs
Sound Volume and On-Off Switch		

Picture Horizontal Hold	}	Dual Control Knobs
Picture Vertical Hold		

Brightness Single Control Knob

NON-OPERATING CONTROLS (not including r-f & i-f adjustments)

Horizontal Centering rear chassis adjustment

Vertical Centering rear chassis adjustment

Width rear chassis screwdriver adjustment

Height rear chassis adjustment

Horizontal Linearity top chassis screwdriver adjustment

Vertical Linearity rear chassis adjustment

Horizontal Drive rear chassis adjustment

Horizontal Oscillator Frequency rear chassis adjustment

Horizontal Oscillator Phase bottom chassis adjustment

Focus rear chassis adjustment

Focus Coil top chassis wing nut adjustment

Ion Trap Magnet Coil top chassis thumb screw adjustment

Deflection Coil top chassis wing nut adjustment

HIGH VOLTAGE WARNING

OPERATION OF THIS RECEIVER OUTSIDE THE CABINET OR WITH THE COVERS REMOVED, INVOLVES A SHOCK HAZARD FROM THE RECEIVER POWER SUPPLIES. WORK ON THE RECEIVER SHOULD NOT BE ATTEMPTED BY ANYONE WHO IS NOT THOROUGHLY FAMILIAR WITH THE PRECAUTIONS NECESSARY WHEN WORKING ON HIGH VOLTAGE EQUIPMENT. DO NOT OPERATE THE RECEIVER WITH THE HIGH VOLTAGE COMPARTMENT SHIELD REMOVED.

KINESCOPE HANDLING PRECAUTIONS

DO NOT OPEN THE KINESCOPE SHIPPING CARTON, INSTALL, REMOVE OR HANDLE THE KINESCOPE IN ANY MANNER UNLESS SHATTERPROOF GOGGLES AND HEAVY GLOVES ARE WORN. PEOPLE NOT SO EQUIPPED SHOULD BE KEPT AWAY WHILE HANDLING KINESCOPES. KEEP THE KINESCOPE AWAY FROM THE BODY WHILE HANDLING.

The Kinescope bulb encloses a high vacuum and, due to its large surface area, is subjected to considerable air pressure. For these reasons, Kinescopes must be handled with more care than ordinary receiving tubes.

The large end of the Kinescope bulb—particularly that part at the rim of the viewing surface—must not be struck, scratched or subjected to more than moderate pressure at any time. In installation, if the tube sticks or fails to slip smoothly into its socket, or deflecting yoke, investigate and remove the cause of the trouble. Do not force the tube. Refer to the Receiver Installation section for detailed instructions on Kinescope Installation. All RCA Kinescopes are shipped in special cartons and should be left in the cartons until ready for installation in the receiver. Keep the carton for possible future use.

TABLE OF CONTENTS

	Page		Page
Alignment Procedure		Operating Instructions	3
Detailed	15	Photographs	
Table	20	Cabinet	1
Antenna	26	Raster	29
Circuit Description	4	Waveform	32
Drawings (Major)		Precautions	
Adjustment Location (Alignment)	22	Cabinet Handling	14
Adjustment Location (Installation)	23	Kinescope Handling	2
Chassis Bottom View	13	Ventilation	26
Chassis Top View	12	Reflections	26
Chassis Wiring Diagram	39	Replacement Parts	43
Circuit Schematic	41	Service Suggestions	26
R-F Unit Wiring Diagram	38	Specifications (Elec. & Mech.)	1
General Description	1	Test Equipment	14
Interference	26	Tube Complement	1
Installation Instructions		Voltage Chart	36
Detailed	23	Warning (High Voltage)	2
Table	25	Wave Traps	11

RECEIVER OPERATING INSTRUCTIONS

The following adjustments are necessary when turning the receiver on for the first time.

1. Turn the receiver "ON" and advance the SOUND VOLUME control to approximately mid-position.
2. Set the STATION SELECTOR to the desired channel.
3. Turn the PICTURE control fully counterclockwise.
4. Turn the BRIGHTNESS control clockwise, until a glow appears on the screen then counterclockwise until the glow just disappears.
5. Turn the PICTURE control clockwise until a glow or pattern appears on the screen.
6. Adjust the FINE TUNING control for best sound fidelity and SOUND VOLUME for suitable volume.
7. Adjust the VERTICAL hold control until the pattern stops vertical movement.
8. Adjust the HORIZONTAL hold control until a picture is obtained and centered.

9. Adjust the PICTURE control for suitable picture contrast.

10. After the receiver has been on for some time, it may be necessary to readjust the FINE TUNING control slightly for improved sound fidelity.

11. In switching from one station to another, it may be necessary to repeat steps number 6 and 9.

12. When the set is turned on again after an idle period, it should not be necessary to repeat the adjustments if the positions of the controls have not been changed. If any adjustment is necessary, step number 6 is generally sufficient.

13. If the position of the controls has been changed, it may be necessary to repeat steps number 1 through 9.

NOTE: If any difficulty is experienced with steps number 7 or 8, turn the PICTURE control ¼ turn counterclockwise and repeat those adjustments.

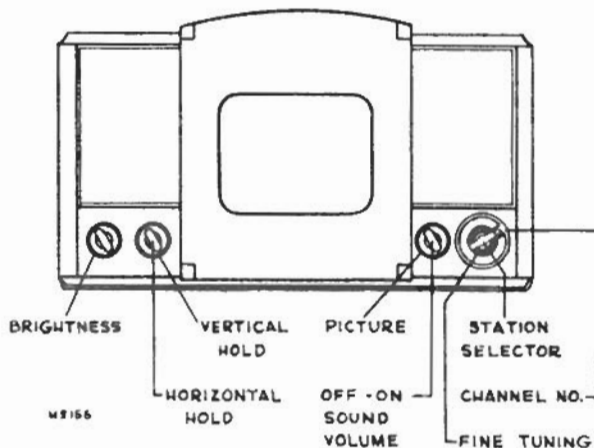


Figure 1—Receiver Operating Controls

630TS

CIRCUIT DESCRIPTION

It is advisable that the reader be familiar with a recent standard textbook of television principles in order to properly understand the receiver circuits and their functions. Such a knowledge is assumed for the purpose of this publication. The discussions which follow will not dwell on the operation of conventional circuits used which have been used in previous receivers and which should be well known. In general, the circuits discussed will be only those that are new to the field.

For ease of understanding the basic operation of the receiver, a 15 unit block diagram of it is shown in Figure 2. The circuit description will follow the numerical order of these blocks in order to logically follow a signal through the set.

R-F UNIT (block # 1)—The r-f unit is a separate subchassis of the receiver. On this subchassis are the r-f amplifier, converter, oscillator, fine tuning control, channel switch, converter transformer, r-f, converter and oscillator coils and all their tuning adjustments. The unit provides operation on all thirteen of the present television channels. It functions to select the desired picture and sound carriers, amplifies and converts to provide at the converter plate, a picture i-f carrier frequency of 25.75 mc. and a sound i-f carrier of 21.25 mc.

R-F Amplifier—Referring to the Schematic Diagram (page 42), T1 is a center tapped coil used for the short circuiting of low frequency signals picked up by the antenna which would otherwise be directly applied to the control grids of the 6J6 r-f amplifier, V1. C1 and C2 are antenna isolating capacitors. The d-c return for the grids of V1 is through R3 and R13 which also properly terminate the 300 ohm antenna transmission line. C3 and C4 are neutralizing capacitors necessary to counteract the grid to plate capacitance of the triode r-f amplifier.

In the plate circuit of the r-f amplifier are a series of inductances L1 to L25 and L2 to L26 inclusive. These inductances may be considered as a quarter wave section of a balanced transmission line which can be tuned over a band of frequencies by moving a shorting bar along the parallel conductors.

Adjustable coils L25 and L26 provide the correct length of line for the thirteenth channel, 210—216 mc. L13 to L23 and L14 to L26 as the shorting bar is moved progressively down the line. The physical construction of each one of these inductances is a small non-adjustable silver strap between the switch contacts. Each strap is cut to represent a six-megacycle change

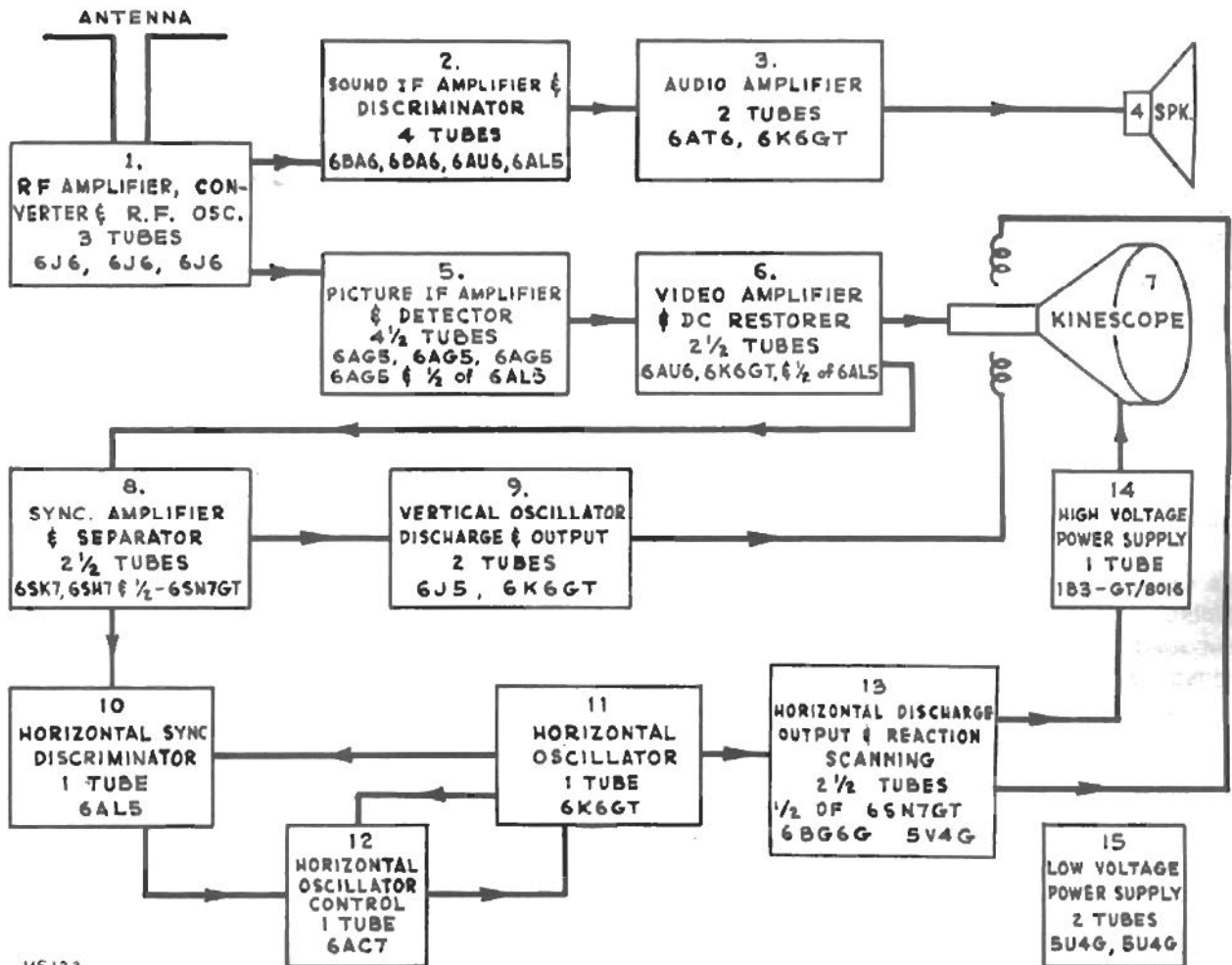


Figure 2—Receiver Block Diagram

CIRCUIT DESCRIPTION

630TS

in frequency. In order to make the jump between the lowest high frequency channel (174-180 mc) and the highest low frequency channel (82-88 mc), adjustable coils L11 and L12 are inserted. To provide for the remaining five low frequency channels, L1 to L9 and L2 to L10 are progressively switched in to add the necessary additional inductance.

Coils L1 to L9 and L2 to L10 are unusual in that they are wound in figure 8 fashion on fingers protruding from the switch wiper. This winding form produces a relatively non-critical coil since the coupling between turns is minimized. A maximum amount of wire is used for the small inductance which is required, thus permitting greater accuracy in manufacturing.

Converter—The converter grid line operates in a similar manner and is so arranged on the switch to provide coupling between it and the r-f line. C10, C12, C13 and a link, provide additional coupling which is arranged to produce at least a 4.5 megacycle band pass on each of the channels.

L80 and C14 form a series resonant circuit used to prevent i-f feedback in the converter by grounding its grids for i-f frequency. They also act as a trap to reject short-wave signals of i-f frequency which arrive at the converter grids in a push push manner.

A 6J6 twin triode is used as converter. Since the grids are fed in push pull by both the signal and the oscillator, the heterodyne products (i-f signals) are in phase on the converter plates so the two plates are connected in parallel. Unwanted signals of i-f frequency that arrive at the converter grid in a push pull manner are out of phase on the converter plates. Since the plates are tied together, these signals tend to cancel thus reducing the possibility of interference from this source.

R-F Oscillator—The oscillator line is similar except that trimmer adjustments are provided for each channel and the low frequency coils are not figure 8 windings. For tuning each channel, brass screws are used in close proximity to the high frequency tuning straps L66 to L76, and brass cores are adjusted through coils L54 to L62. It is obvious that the high frequency adjustments should be made before each lower frequency one.

C15 is a fine tuning adjustment which provides approximately plus or minus 300 kc. variation of oscillator frequency on channel 1 and approximately plus or minus 750 kc. on channel 13. On a few early production units, slightly less range is available.

The physical location of the oscillator line with respect to the converter grid line is such as to provide some coupling to the converter grids. This coupling is augmented by the link shown on the schematic and provides a reasonably uniform oscillator voltage at the converter grids over the entire tuning range of the unit.

The converter transformer T2 is a combination picture i-f transformer, sound trap, and sound i-f transformer. The converter plate coil is assembled within the structure of a high Q resonant circuit tuned to the sound i-f frequency. This high Q coil absorbs the sound i-f component from the primary. Thus on the T2 primary (from which the picture i-f is fed), the sound carrier is attenuated with relation to the picture channel.

SOUND I-F AMPLIFIER AND DISCRIMINATOR (block #2)—A portion of the energy absorbed by the T2 trap circuit is fed to the first sound i-f amplifier. Three stages of amplification are used to provide adequate sensitivity. A conventional discriminator is used to demodulate the signal. The discriminator band width is approximately 350 kc. between peaks.

AUDIO AMPLIFIER AND SPEAKER (block #3 and 4)—The audio amplifier is a conventional system employing a 6AT6 high mu. triode amplifier and a 6K6GT power output tube feeding a 5-inch E.M. dynamic speaker.

PICTURE I-F AMPLIFIER AND DETECTOR (block #5)—The picture i-f amplifier departs considerably from the conventional coupled amplifier. To obtain the necessary wide band characteristic with adequate gain, four stages of i-f amplification are employed. The converter plate and each successive i-f transformer utilizes only one tuned circuit and each is tuned to a different frequency. The effective Q of each coil is fixed by the shunt plate load or grid resistor so that the response product of the total number of stages produces the desired overall response curve. Figure 3 shows the relative gains and selectivities of each coil and the shape of the curve of the quintuple combination.

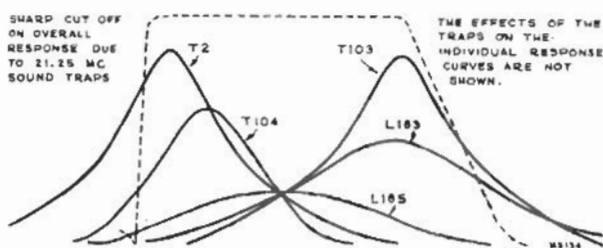


Figure 3—Stagger Tuned I-F Response

In order to obtain this band pass characteristic, the picture i-f transformers are tuned as follows:

Converter transformer	21.8 mc. (T2 primary)
First pix i-f transformer	25.3 mc. (T103 primary)
Second pix i-f transformer	22.3 mc (T104 primary)
Third pix i-f coil	25.2 mc. (L183)
Fourth pix i-f coil	23.4 mc. (L185)

In such a stagger tuned system variations of individual i-f amplifier tube gain do not affect the shape of the overall i-f response curve if the Q and center frequency of the stages remain unchanged. This means that the i-f amplifier tubes are

non-critical in replacement because variations in G_m do not affect response shape.

To align the i-f system, the transformers are peaked to the specified frequencies with a signal generator. The overall i-f response is then observed by use of a sweep generator and oscilloscope. Slight deviations from standard circuit Q are compensated for with slight shifts in transformer center frequency until the desired response curve is obtained. If this response cannot be obtained, the difficulty is likely to be in a location that affects either the frequency or Q of one or more of the i-f transformers.

The response curve does shift slightly as the picture control is varied due to the Miller effect. This effect is the change in tube input capacitance as its gain is varied by grid bias changes. The change of input capacitance causes a slight detuning of the preceding i-f transformer and a small shift in response shape. This effect is slight, however, and when the receiver is aligned with the specified grid bias, no difficulty from this source should be encountered.

For familiarization with the frequencies which are important in the receiver's operation, Figure 4 shows the relative position of the picture and sound carriers for channels 2, 3 and 4. If a station on channel 3 is transmitting a picture with video frequencies up to 4 mc., the picture carrier will have side band frequencies up to 65.25 mc. The lower side bands are suppressed at the transmitter.

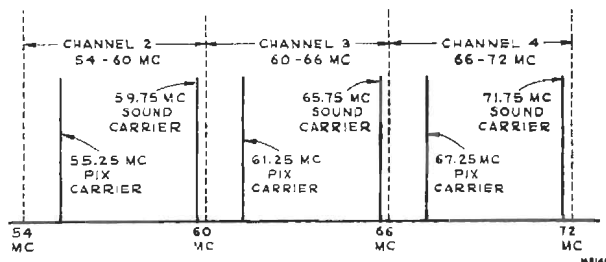


Figure 4—Television Channel Frequencies

With the receiver r-f oscillator operating at a higher frequency than the received channel, the i-f frequency relation of picture to sound carrier is reversed as shown in Figure 5.

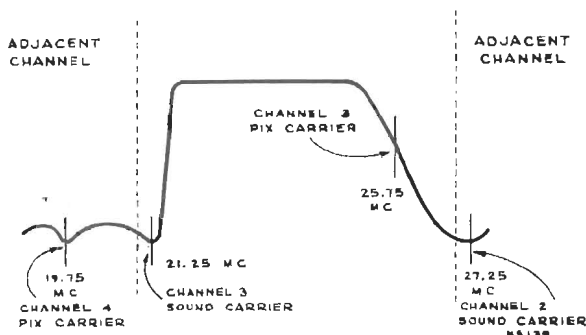


Figure 5—Overall Picture I-F Response

Traps—Since it is necessary for the picture i-f to pass frequencies quite close to the sound carrier frequency, the sound carrier would produce interference in the picture. In order to prevent this interference, traps must be added to the picture i-f amplifier to attenuate the sound carrier. If the receiver should be operating on channel 3, it is possible that interference would be experienced from the channel 2 sound carrier and the channel 4 picture carrier. The adjacent channel traps are provided to attenuate these unwanted frequencies.

The first three traps are absorption circuits. The first trap (T2 secondary) is tuned to the accompanying sound i-f frequency, the second trap (T103 secondary) is tuned to the adjacent channel sound frequency, and the third trap (T104 secondary) tuned to the adjacent channel picture carrier frequency. The fourth trap (T105 secondary) is in the cathode circuit of the fourth picture i-f amplifier V113 and is tuned to the accompanying sound carrier i-f frequency. The primary of T105 in series with C181 forms a series resonant circuit at the frequency to which L185 is tuned (23.4 mc.). This provides a low impedance in the cathode circuit at this frequency and permits the tube to operate with a gain. However, at the resonant frequency of the secondary (21.25 mc.), a high impedance is reflected into the cathode circuit, and the gain of the tube for this frequency is reduced by degeneration. The rejection with this circuit is limited to the gain of the tube.

Picture Second Detector—The detector is a conventional half wave rectifier connected to produce a video signal of the proper polarity.

Picture Control—The picture (or contrast) control varies the bias on the r-f amplifier and the first, second and third i-f amplifier control grids. It is a manual sensitivity control, and is operated to prevent overloading of the i-f stages and to provide the correct video output level from the second detector. A novel arrangement is used in conjunction with the control. The object of this system is to provide optimum signal to noise ratio from the receiver. This is achieved by allowing the r-f amplifier to run essentially at full gain over a considerable range of the picture control. The gain in the r-f stage is reduced only when it becomes necessary to do so in order to prevent overloading of the first i-f stage. The circuit shown in Figure 6 is used to provide the non-proportional r-f and i-f bias from a single control.

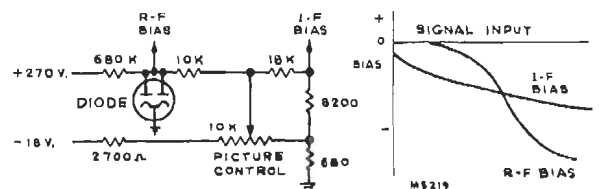


Figure 6—Picture Control Circuit

When the picture control is in the maximum gain position, the i-f bias is approximately minus one volt. The r-f bias is taken

CIRCUIT DESCRIPTION

630TS

from a tap up the control network which would be several volts positive except for relatively heavy conduction of the diode. Diode conduction holds the voltage at this point to approximately ground potential.

As the picture control gain setting is reduced slightly, the i-f bias begins to go more negative. At the r-f bias junction, diode conduction is reduced but the voltage remains essentially constant. When the picture control setting is reduced still further, diode conduction is stopped and the r-f bias voltage changes rapidly to assume a more negative potential than the i-f grid.

This high value of bias on the r-f amplifier is necessary to reduce the triode nearly to cut-off. Although triodes are not generally considered to be remote cut-off tubes, sufficient curvature is present in the grid control characteristic to provide approximately a ten to one reduction in gain when the bias approaches the cut-off point.

VIDEO AMPLIFIER AND D-C RESTORER (block #6)—The function of this section of the receiver is to amplify the video output of the second detector. Two amplifier stages are employed. The gain from the first video grid to output plate is 30X and the frequency response extends to 4 mc.

Noise Saturation Circuit—Since the synchronizing pulse is "blacker than black" and "black" information must drive the Kinescope grid toward cut-off, this means that the video signal polarity must be such that the sync is negative when applied to the Kinescope grid. It is obvious that for the two-stage video amplifier as is used, the sync pulse from the second detector must also be negative at the first video amplifier grid. The first stage is designed so that with a normal signal input level at its grid, the tube will be working over most of its operating range. Any large noise signal above sync will drive the grid to cut-off and the noise will be limited. In effect, the signal to noise ratio is thus improved.

D-C Restorer—Since the video amplifier is an a-c amplifier, the d-c component of the video signal that represents the average illumination of the original scene will not be passed. Unless this d-c component is restored, difficulty will be experienced in maintaining proper scene illumination. For any given scene, this average illumination could be set properly by the brightness control. However, a change of scene would probably necessitate resetting this control. The d-c restorer accomplishes this setting automatically thus assuring proper picture illumination at all times. For a detailed explanation of the operation of the d-c restorer, see "Practical Television by RCA."

KINESCOPE (block #7)—The Kinescope is a 10" tube employing a new type screen material which provides considerably improved picture brilliance. The tube employs magnetic deflection and magnetic focus. An ion trap is employed to prevent the ion beam from producing a brown spot on the picture

screen. The inside and outside of the flaring portion of the bulb are given a metallic coating. The inner coating, which is the second anode, is connected to the high voltage supply. The outer coating is grounded by means of two small springs on the deflection yoke support. The capacity between the two coatings is approximately 500 mmf and is used as a high voltage filter condenser.

SYNC AMPLIFIER AND SEPARATOR (block #8)—The function of this system is to amplify the sync signal and effect separation of sync from the video.

Sync Amplifier—The first sync amplifier V118 is a 6SK7 which has a remote cut-off characteristic. The signal from the d-c restorer is fed into this amplifier with the polarity such that the sync is in the negative direction. Noise pulses above sync that remain after the limiting action of the first video grid are thus further compressed and the sync to noise ratio is again improved.

Sync Separator—The sync at the sync separator grid is positive in polarity. The operating voltages applied to the grid, screen and plate, are such that the negative portion of the applied signal is cut off. Thus, the video and blanking pulses are removed and only the sync pulses appear at the sync separator plate.

Second Sync Amplifier—The sync pulses appearing at the second sync amplifier, (V120A), grid are negative in polarity and must be inverted before they can be injected into the sweep oscillators. The signal at the V120A grid is sufficient to drive the tube beyond cut-off and the signal is again clipped. This final clipping removes all amplitude variations between sync pulses due to noise, hum, etc., and it appears with the correct polarity at the plate.

Integrating Network—The purpose of this network is to separate the horizontal from the vertical sync and to pass the vertical to the vertical oscillator.

Since the horizontal sync pulse is of short duration (5 microseconds) and the vertical pulse is of much longer duration (190 microseconds), they can be separated by an r-c filter which is responsive to wave shape. The integrating network which is such a filter is composed of R163, R164, R165, C151, C152 and C153. In operation it can be considered as a low-pass filter which by-passes the narrow or high frequency horizontal sync but passes the broad or low frequency vertical sync.

VERTICAL OSCILLATOR DISCHARGE AND OUTPUT (block #9)—The function of these circuits is to provide a sawtooth of current of the proper frequency and phase to perform the vertical scanning for the Kinescope. To produce such a current in the vertical deflection coil, a somewhat different shaped voltage wave is required.

Since the vertical trace is slow, requiring approximately 16,000 microseconds, and the vertical deflection coil inductance is small, approximately 50 millihenries, the majority of the voltage across the coil during trace is across its resistive component. In order to produce a linear change of current through a resistance, a linear change of voltage is necessary. Retrace, however, must be accomplished within the 666 microsecond vertical blanking time and therefore requires a much faster rate of change of current through the coil. During this time, the effect of its inductance becomes appreciable because of the required fast rate of change of current. It is therefore necessary to apply a large pulse of voltage across the coil in order to obtain rapid retrace. The composite waveform required to produce a sawtooth of current in the coil is a sawtooth of voltage with a sharp pulse as shown in Figure 7. V121 and V122 supply such a voltage.

Vertical Oscillator and Discharge—A single 6J5 triode, V121, with its associated components form a blocking oscillator and discharge circuit. The wave form of the voltage at the control grid of this tube with respect to time, is a small, positive surge followed by a large negative drop which returns to the positive condition at a relatively slow rate. During the negative part of the cycle, the grid is beyond cut-off and the discharge capacitor, C158, charges through resistors R169 and R170. When the grid reaches a voltage that permits plate to cathode conduction, C158 discharges through T106 secondary and V121. The discharge current of C158 builds up a magnetic field in T106 that in turn induces a positive voltage at the grid of V121. This positive voltage on the V121 grid lowers the plate resistance of the tube and allows C158 to discharge more rapidly. This process builds up very rapidly until C158 is nearly discharged. The magnetic field in T106 then collapses and drives the V121 grid negative. The charge placed on C154 due to grid conduction during the positive pulse now holds the grid negative. As the charge on C154 leaks off through R171, R172, etc., the grid slowly becomes less negative and approaches the point which will allow plate to cathode conduction. Just before the conduction point is reached, the 60 cycle vertical synchronizing pulse from the integrating network is applied to the V121 grid. This pulse is sufficient to drive the tube to conduction and the process is repeated. In this manner, the incoming sync maintains control of vertical scanning.

On the plate of V121, a sawtooth of voltage appears due to the slow charging and rapid discharging of C158. A sharp negative pulse also occurs during the discharge period. See Figure 7. This pulse appears because of the action of R174 and C158, an action which is known as peaking. When V121 is conducting, the plate voltage drops nearly to cathode potential. C158 discharges during this time. However, since the conduction time is short, C158 cannot be completely discharged due to the time constant of R174 in series with C158. When V121 becomes non-conducting, the plate voltage does not have to rise slowly from cathode potential but instead rises immediately to an appreciable value due to the charge that

remains on C158. The plate voltage then slowly rises from this value as C158 charges through R170 and R169. Adjustment of the height control R169 varies the amplitude of the sawtooth voltage on V121 plate by controlling the rate at which C158 can charge.

The voltage present on the V121 plate is of the shape required to produce a sawtooth of current in the vertical deflection coil. It is now necessary to amplify it in a tube capable of supplying a sufficient amount of power.

Vertical Output—A 6K6GT is connected as a triode for the output stage, V122. The vertical output transformer T107 matches the resistance of the vertical deflection coils to the plate impedance of the 6K6GT.

R178 is provided as a vertical sweep linearity control. Since the grid control characteristic curve of V122 is not a straight line over its entire range, the effect of adjustments of R178 is to produce slight variations in shape of the sawtooth by shifting the operating point of the tube to different points along the curve.

Since the slope of the curve varies at these different points and thus varies the effective gain of the tube, it is apparent that adjustments of linearity effect picture height and that such adjustments must be accompanied by readjustments of the height control R169. Adjustments of the height control affect the shape of the sawtooth voltage on V121 plate so that adjustments of height must be accompanied by readjustments of linearity.

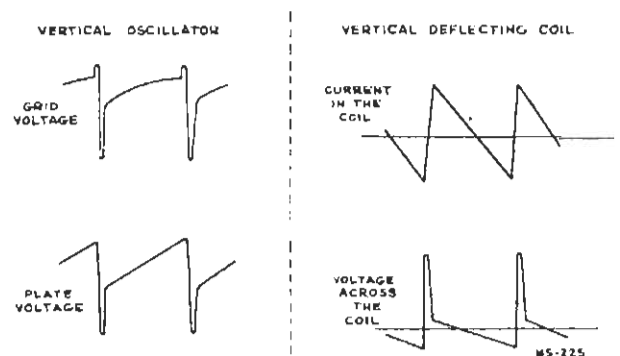


Figure 7—Vertical Sweep Waveforms

HORIZONTAL SYNC DISCRIMINATOR, HORIZONTAL OSCILLATOR AND OSCILLATOR CONTROL (block #10, 11 and 12)

—These circuits are a radical departure from the conventional systems used for framing the picture in the horizontal direction. Their features are ease of operation, stability and good noise immunity.

HORIZONTAL OSCILLATOR (block #11)—The horizontal oscillator is an extremely stable Hartley oscillator operating at the scanning frequency 15,750 cps. The primary of T108 (terminals A, B and C) is the oscillator coil. This coil is closely coupled to the secondary winding (terminals D, E and F) and thus feeds a sine wave voltage to V123.

CIRCUIT DESCRIPTION

630TS

HORIZONTAL SYNC DISCRIMINATOR (block #10)—The sync discriminator, V123, is a 6AL5 dual diode in a circuit which produces a d-c output voltage proportional to the phase displacement between two input voltages.

The sine wave oscillator voltages applied to the plates of V123 are equal in amplitude and opposite in phase. The synchronizing pulses from the second sync amplifier are fed through a differentiating network to attenuate the vertical sync and then applied to the center tap of T108. The horizontal sync pulses thus appear in phase and of equal amplitude on the diode plates as shown in Figure 8. When the pulse and sine wave are properly phased as in (A), both diodes will produce equal voltage across their load resistances, R191 and R192. However, these voltages are of opposing polarity and therefore the sum of the voltages across these two load resistors will be zero. If the phase of the pulse changes with respect to the sine wave as in (B), the top diode will produce more voltage across R191 than the bottom diode produces across R192. Thus, the voltage across the two will be positive. In (C) the reverse condition exists. It is obvious that the output of the discriminator can swing from positive through zero to negative dependent upon the phase relation of the synchronizing signal and the oscillator. This d-c output is applied to the grid of V124.

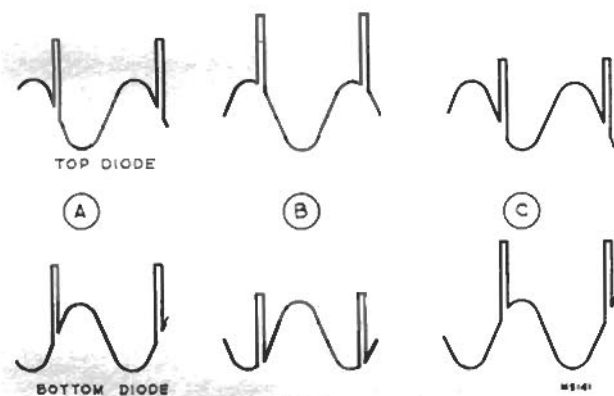


Figure 8—Sync Discriminator Waveforms

HORIZONTAL OSCILLATOR CONTROL (block # 12)—V124 the oscillator control is a 6AC7 connected as a reactance tube across the V125 oscillator coil. A change in the d-c output of the discriminator produces a change in Gm of V124 which in turn changes the frequency of the oscillator. If the phase of the oscillator shifts with respect to the synchronizing pulse, the corresponding change in d-c from the discriminator brings the oscillator back into correct phase. C167 and C170 form a voltage divider to attenuate rapid changes in d-c from the sync discriminator such as are produced by vertical sync or bursts of noise.

Sync Link—If any phase modulation is present in the transmitted sync, a condition which unfortunately still exists in some transmitters to date, a faster response to fluctuations in the sync phase is needed than is provided by the ratio of C167 to C170.

The sync discriminator will demodulate sync phase variation quite faithfully, however, the filter resistor R193 together with the capacity attenuator, C167 and C170 is just as effective in removing this information as it is with respect to the noise disturbances for which it is intended. The removal of this information will produce a horizontal displacement of portions of the picture.

It may be necessary in some instances to sacrifice some noise immunity to compensate for phase modulation in the transmitted sync. By switching the link provided for this purpose, C171 is added across C167 and the speed of response is increased by several times. Therefore, the link of J102 should be connected between terminals 1 and 2 whenever this condition exists.

Before making this change, however, it should first be definitely determined that distortion of the raster is due to phase modulation of the sync. Horizontal "jitter" and distortion of the raster can be caused by operating the picture control at too great a gain setting considering the r-f signal input. Such a setting produces an excessive video signal at the first video amplifier grid. This stage is designed to limit an excessive input in order to improve the signal to noise ratio. If the video input is excessive, the sync is limited and thus removed. At the same time, picture information may be introduced into the sync circuits which may make their operation unstable. With extreme excesses of video level, both horizontal and vertical sync may be lost. If the receiver operating instructions on page 3 are followed, no difficulty should be experienced with the picture control setting.

In late production receivers the link has been removed from the oscillator control circuit leaving it in link from 2 to 3 condition. To check the connection of the link board, tune in a picture and place the finger on terminal 3. If the picture is displaced horizontally the board is connected to the oscillator control circuit. If no such pulling is observed, it indicates that that receiver is connected to employ the board for a video peaking link.

HORIZONTAL DISCHARGE OUTPUT AND REACTION SCANNING (block # 13)—The purpose of these circuits is to produce a sawtooth of current in the deflection coils to provide horizontal scanning for the Kinescope.

Horizontal Discharge—One-half of a 6SN7GT is employed for the discharge tube V120B. The function of this stage is to produce a sawtooth voltage for use in the horizontal sweep circuits.

The oscillation in V125 takes place between screen-grid and cathode. Since the peak to peak voltage on its grid is approximately 95 volts, a square wave is produced on its plate. This wave is differentiated by C176 and R202, and the pulse so obtained is applied to the grid of the discharge tube V120B.

The discharge tube is normally cut off due to bias produced by grid rectification of these incoming pulses. The pulse from V125 overcomes this bias and drives the tube into heavy momentary conduction. During this period the plate voltage falls nearly to cathode potential and C179 discharges rapidly. However, since the period of conduction is quite short, C179 is not completely discharged due to the time constant introduced by R187 and R210 in series with C179. Then when V120B again becomes non conducting, the plate voltage rises quickly to a value determined by the charge remaining on C179. From this point the plate voltage rises slowly and approximately linearly as C179 charges through R204.

Horizontal Output and Reaction Scanning—The operation of these two circuits is so interconnected that it will be necessary to discuss them simultaneously. The function of the output tube V126 is to supply sufficient current of the proper wave form to the horizontal deflection coil in order to provide horizontal scanning for the Kinescope. The function of the reaction scanning tube V128 is to stop oscillation of certain components at certain times and thus help provide a linear trace. Other functions of these circuits include the utilization of energy stored in the horizontal deflection coil to furnish retrace and Kinescope high voltage. The reaction scanning circuit also recovers some of the energy from the yoke kickback and uses it to help supply the plate power requirements of the output tube.

In operation, the visible portion of the horizontal trace is approximately 53 microseconds in duration. Although the inductance of the horizontal deflection coil is in the order of 8 millihenries, at the horizontal scanning frequency, the reactance of the coil predominates over its resistance. This is a different case than that encountered in the vertical deflection system and so a different method of operation must be employed.

Horizontal blanking is approximately 10 microseconds in duration. During this time, the Kinescope beam must be returned to the left side of the tube, the trace started and made linear. In order that all this be accomplished within the horizontal blanking time, only 7 microseconds can be allowed for the return trace. In order to obtain such rapid retrace, the horizontal deflection coil, output transformer and associated circuits are designed to resonate at a frequency such that one half cycle of oscillation at this frequency will occur in the 7 microseconds retrace time limit.

During the latter part of the horizontal trace, the output tube conducts very heavily and builds up a strong magnetic field in the deflection coil and output transformer. When the negative pulse from the horizontal tube is applied to the output tube grid, its plate current is suddenly cut off and the magnetic field in the transformer and deflection coil begins to collapse at a rate determined by the resonant frequency of the system. Actually the system is shock excited into oscillation. Since the output tube is cut off and since the voltage generated by the collapsing field is negative on the reaction scanning

tube plate so that it is non-conductive, there is essentially no load on the circuit and it oscillates vigorously for one half cycle. If the reaction scanning tube were not present, the circuit would continue to oscillate as shown in Figure 9 (A). This condition, however, is not permitted. One half cycle of oscillation is permitted because at the end of such a time the current in the deflection coil has reached a maximum in the opposite direction to which it was flowing at the end of the trace period. This reversal of the direction of flow of current was the requirement for retrace and it was accomplished in the allotted 7 microseconds.

Now the retrace has been completed, it is necessary to start the next trace. The energy which was placed in the deflection coil by the output tube in the later part of the last trace has not been dissipated. During the one-half cycle of oscillation retrace was accomplished with very little loss of energy. The field in the coil was merely reversed in polarity. So, at this point, a strong field exists in the deflection coil.

As mentioned previously, if the coil were not damped, it would continue to oscillate at its natural frequency as shown in Figure 9 (A). To prevent such an oscillation the reaction scanning tube is brought into action. This tube is in a modified damper circuit which is effectively connected across the deflecting coil.

In the oscillating circuit, the current in the deflection coil lags the voltage by approximately 90 degrees and when the current has reached its maximum negative value, the voltage across the coil being 90 degrees ahead, has begun to swing positive. When the voltage on the reaction scanning tube plate becomes positive with respect to its cathode, it begins to conduct heavily. This places such a load across the deflection coil that it cannot oscillate. Instead the field begins to decay at a rate permitted by the load which the reaction scanning tube placed on the coil. The circuit constants are such that this decay is linear and at a rate suitable for the visible trace.

If no additional energy were fed into the coil, the field would fall to zero and the Kinescope beam would come to rest in the center of the tube. In such an *r-l* circuit, as the current approaches its final value, it does not do so linearly but asymptotically as indicated in Figure 9 (B). It is therefore necessary to have the output tube begin to supply power to the deflection coil before the energy in the coil is completely dissipated. Figure 9 (C) shows the shape of the current supplied by the output tube. Although the currents supplied by the output tube and by the decaying field are curved at the cross over point, together they produce a coil current that is linear.

By the time the beam has reached the right side of the Kinescope, the output tube is conducting heavily and has built up a strong field in the transformer and coil. At this point, the output tube is again suddenly cut off and the process is repeated.

CIRCUIT DESCRIPTION

630TS

The 6BG6G plate voltage is supplied through the 5V4G which is conducting over the major portion of the trace. Capacitors C186 and C188 are charged during this period and this charge is sufficient to supply the 6BG6G plate when the 5V4G is not conducting.

The charge is placed on these capacitors by the receiver d-c supply and by the current from the collapse of the field in the horizontal deflecting coil. The a-c axis of the sweep voltage is 275 volts above ground since the T109 secondary is connected to the receiver 275 volt bus. The charge placed on these capacitors by the coil kick-back is therefore in addition to that from the d-c supply and thus the capacitors are charged to a voltage greater than the d-c supply. This permits operation of the 6BG6G at a higher voltage than is obtainable from the receiver power supply and produces an increase in the system efficiency by salvaging energy that would otherwise have been wasted.

During the trace period, the voltage across C186 varies due to the charging by the deflection coil kickback and discharging throughout the output tube. This rise and fall of voltage constitutes an a-c "ripple" in the plate supply of the output tube. By shifting the phase of this ripple with respect to the tube plate current requirements, slight variations of plate characteristics are obtained. L201 and C188 constitute a phase shifting network. L201 is variable and is provided to effect small improvements in linearity. Counterclockwise rotation of the adjustment screw causes the second quarter of the picture to stretch and the first quarter to crowd.

R187, the horizontal drive control, determines the ratio of high peaking and sawtooth voltage on the grid of the output tube and thus affects the point on the trace at which the tube conducts. Clockwise rotation of control increases picture width, crowds the right side of the picture and stretches the left side. L196 is provided to vary the output and hence the picture width by shunting a portion of the T109 secondary winding. Clockwise rotation of the adjustment increases the picture width and causes the right side of the picture to stretch slightly.

Antenna Wave Trap:

In some instances interference may be encountered from FM stations that are on the image frequency of a television station. In other instances interference between two television stations may be observed.

Assume that two television stations in a city are operating on channels 6 and 10. When the receiver is tuned to channel 6, a small amount of the oscillator voltage (109 mc.) is present on the r-f amplifier grid. This 109 mc. voltage beats with the channel 10 picture carrier and produces an 84.25 mc. signal. This signal falls within the channel 6 range and interferes with the reception of channel 6. A similar case occurs between channels 5 and 7.

A series resonant trap across the r-f amplifier grid circuit will remove the oscillator voltage from the grids and will minimize this type of interference. Such a trap was installed on those receives which experienced this type of interference.

To adjust the trap, tune in the station on which the interference is observed. Tune both cores of the trap for minimum interference in the picture. Keep both cores approximately equal. Turn one core $\frac{1}{2}$ turn from the original position, then readjust the second core for minimum interference in the picture. Repeat until the best rejection is obtained. For shop alignment the cores of this trap should be run out before proceeding with r-f and converter line adjustment. After the receiver alignment is completed, the trap should be returned.

Refer to page 227 (621TS, page 29) for schematic and wiring of antenna trap.

R209 is a damping resistor inserted to control trace linearity on the left side of the picture. A high and low tap is provided on this resistor by which variations in the yoke and output transformer can be compensated for. This tap is set in the factory and probably will not have to be changed in the field.

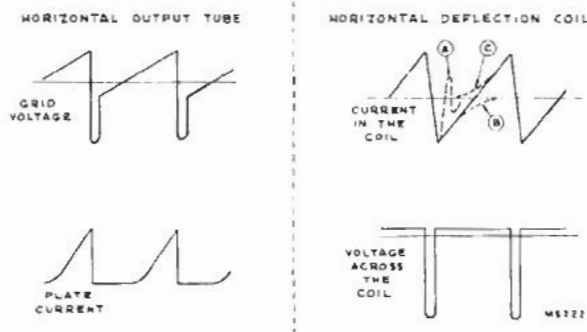


Figure 9—Horizontal Sweep Waveforms

HIGH VOLTAGE POWER SUPPLY (block # 14) The Kinescope high voltage supply is unusual in that the power is obtained from the energy stored in the deflection inductances during each horizontal scan. When the 6BG6G plate current is cut off by the incoming signal, a positive pulse appears on the T109 primary due to the collapsing field in the deflection coil. This pulse of voltage is stepped up, rectified, filtered and applied to the second anode of the kinescope. Since the frequency of the supply voltage is high, (15,750 cps), relatively little filter capacity is necessary. Since the filter capacity is small, the stored energy is small, and the high voltage supply is made less dangerous.

LOW VOLTAGE POWER SUPPLY (block # 15)—The low voltage power supply provides the filament and plate voltages for the receiver. The unit is conventional, and employs two 5U4G rectifier tubes in parallel to supply 400 volts d-c at approximately 290 ma. The speaker field is used as filter choke for all but the sound output tube which uses an r-c filter.

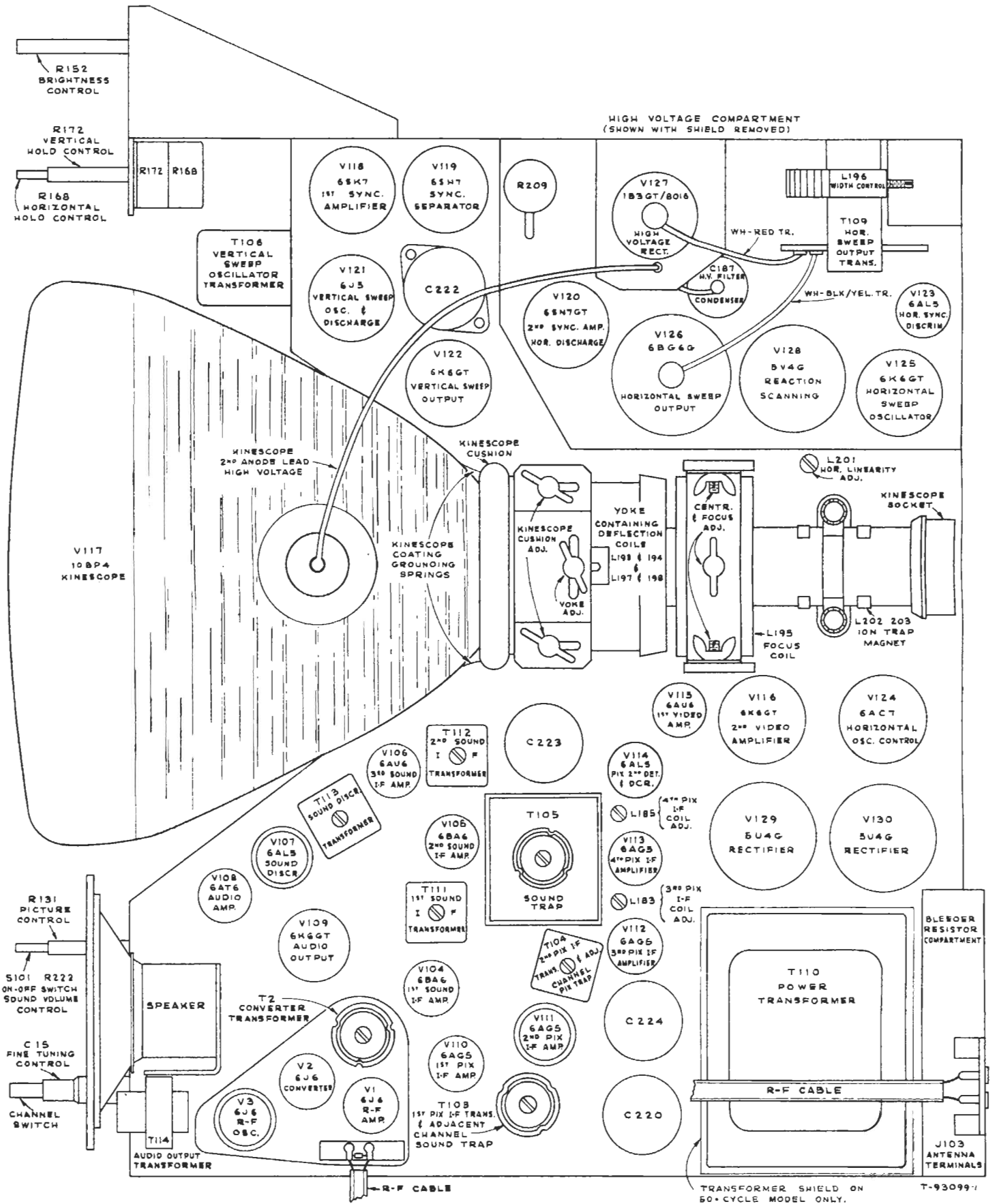


Figure 10—Chassis Top View

TEST EQUIPMENT—To properly service this receiver, it is recommended that the following test equipment be available:

R-F Sweep Generator meeting the following requirements:

- (a) Frequency Ranges
 - 18 to 30 mc., 1 mc. sweep width
 - 40 to 90 mc., 10 mc. sweep width
 - 170 to 225 mc., 10 mc. sweep width
- (b) Output adjustable with at least 1 volt maximum.
- (c) Output constant on all ranges.
- (d) "Flat" output on all attenuator positions.

Cathode-ray Oscilloscope, preferably one with a wide band vertical deflection, an input calibrating source, and a low capacity probe.

Signal Generator to provide the following frequencies.

(a) I-F frequencies

- 19.75 mc. adjacent channel picture trap
- 21.25 mc. sound i-f and sound traps
- 21.8 mc. convertor transformer
- 22.3 mc. second picture i-f transformer
- 23.4 mc. fourth picture i-f coil
- 25.2 mc. third picture i-f coil
- 25.3 mc. first picture i-f transformer
- 25.75 mc. picture carrier
- 27.25 mc. adjacent channel sound trap

(b) R-F frequencies

Channel Number	Picture Carrier Freq. Mc.	Sound Carrier Freq. Mc.
1	45.25	49.75
2	55.25	59.75
3	61.25	65.75
4	67.25	71.75
5	77.25	81.75
6	83.25	87.75
7	175.25	179.75
8	181.25	185.75
9	187.25	191.75
10	193.25	197.75
11	199.25	203.75
12	205.25	209.75
13	211.25	215.75

(c) Output on these ranges should be adjustable and at least 1 volt maximum.

Heterodyne Frequency Meter with crystal calibrator if the signal generator is not crystal controlled.

Electronic Voltmeter of Junior "VoltOhmyst" type and a high voltage multiplier probe for use with this meter to permit measurements up to 10 kv.

SERVICE PRECAUTIONS—Cutouts in the bottom of the cabinet make it possible to do much of the servicing of the receiver without removing the chassis. If the receiver is serviced in cabinet, a soft pad should be placed under the cabinet when it is inverted, in order to avoid scratching the surface. In manufacture, the cabinet receives a Class 1 rub finish and every effort should be made to preserve that finish. The receiver handling precaution on page 23 should also be observed.

If necessary to remove the chassis from cabinet, the Kinescope must first be removed. See Figures 22, 24 and 26. If possible, the chassis should then be serviced without the Kinescope. However, if it is necessary to view the raster during servicing, the Kinescope should be inserted only after the chassis is turned on end. The Kinescope should never be allowed to support its weight by resting in the deflecting yoke. A bracket should be used to support the tube at its viewing screen.

By turning the chassis on end with the power transformer down, all adjustments will be made conveniently available. Since this is the only safe position in which the chassis will rest and still leave all adjustments accessible, the trimmer location drawings are oriented similarly for ease of use.

CAUTION: Do not short the Kinescope second anode lead. Its short circuit current is approximately 3 ma. This represents approximately 9 watts dissipation and a considerable overload on the high voltage filter resistor R235.

Adjustments Required—Normally, only the r-f oscillator line will require the attention of the service technician. All other circuits are either broad or very stable and hence will seldom require re-adjustment.

Due to the high frequencies at which the receiver operates, the r-f oscillator line adjustment is critical and may be affected by a tube change. The line can be adjusted to proper frequency on channel 13 with practically any 6J6 tube in the socket. However, it may not then be possible to adjust the line to frequency on all of channels 7, 8, 9, 10, 11 and 12. To be satisfactory as an oscillator tube, it should be possible to adjust the line to proper frequency with the fine tuning control in the middle third of its range. It may therefore be necessary to select a tube for the oscillator socket. In replacing, if the old tube can be matched for frequency by trying several new ones, this practice is recommended. At best, however, it will probably be necessary to completely realign the oscillator line when changing the tube.

Tubes which cannot be used as oscillator will work satisfactorily as r-f amplifier or converter.

ALIGNMENT PROCEDURE

630TS

The detailed alignment procedure which follows is intended primarily as a discussion of the method used, precautions to be taken and the reasons for these precautions. Then, for more convenient reference during alignment, a tabulation of the method is given. All the information necessary for alignment is given in the table, however, alignment by the table should not be attempted before reading the detailed instructions.

ORDER OF ALIGNMENT—When a complete receiver alignment is necessary, it can be most conveniently performed in the following order:—

- Picture i-f traps
- Picture i-f transformers
- Sound discriminator
- Sound i-f transformers
- R-F and converter lines
- R-F oscillator line
- Converter grid trap.
- Retouch picture i-f transformers
- Sensitivity check

PICTURE I-F TRAP ADJUSTMENT-

Set the voltage on the i-f bias bus to approximately -3 volts. Set the channel switch to channel 9.

Connect the "VoltOhmyst" across the picture second detector load resistor R137.

Connect the output of the signal generator to the junction of L80 and R6. This connection is available on a terminal lug through a hole in the side apron of the chassis beside the r-f unit.

Set the generator to each of the following frequencies and tune the specified adjustment for minimum indication on the VoltOhmyst. In each instance the generator should be checked against a crystal calibrator to insure that the generator is exactly on frequency.

- 19.75 mc. -T104 (top)
- 21.25 mc. -T2 (top)
- 21.25 mc. -T105 (top)
- 27.25 mc. T103 (top)

PICTURE I-F TRANSFORMER ADJUSTMENTS

Set the signal generator to each of the following frequencies and peak the specified adjustment for maximum indication on the "VoltOhmyst."

- 21.8 mc. -T2 (bottom)
- 25.3 mc. -T103 (bottom)
- 22.3 mc. -T104 (bottom)
- 25.2 mc. -L183 (top of chassis)
- 23.4 mc. L185 (top of chassis)

If T104 (bottom) required adjustment, it will be necessary to reset T104 (top) for minimum response at 19.75 mc.

Picture I-F Oscillation If the receiver is badly misaligned and two or more of the i-f transformers are tuned to the same

frequency, the receiver may fall into i-f oscillation. I-F oscillation shows up as a voltage in excess of 3 volts at the picture detector load resistor. This voltage is unaffected by r-f signal input and sometimes is independent of picture control setting.

If such a condition is encountered, it is sometimes possible to stop oscillation by adjusting the transformers approximately to frequency by setting the adjustment stud extensions of T2, T103, T104, T105, L183, and L185 to be approximately equal to those of another receiver known to be in proper alignment. If this does not have the desired effect, it may now be possible to stop oscillation by increasing the grid bias with the picture control. If so, it should then be possible to align the transformers by the usual method. Once aligned in this manner, the i-f should be stable with reduced bias.

If the oscillation cannot be stopped in the above manner, shunt the grids of the first three i-f amplifiers to ground with 1000 mmf. capacitors.

Connect the signal generator to the fourth i-f grid and adjust L185 to frequency.

Remove the shunting capacitor from the third i-f grid, connect the signal generator to this grid and align L183.

Remove the shunting capacitor from the second i-f grid, connect the signal generator and align T104.

Remove the shunting capacitor from the first i-f grid, connect the signal generator and align T103.

Connect the signal generator to the junction of L80 and R6, and align T2 to frequency.

If this does not stop the oscillation, the difficulty is not due to i-f misalignment as the i-f section is very stable when properly aligned. Check all i-f by-pass condensers, transformer shunting resistors, tubes, socket voltages, etc.

SOUND DISCRIMINATOR ALIGNMENT-

Set the signal generator for approximately 1 volt output at 21.25 mc. and connect it to the third sound i-f grid.

Detune T113 secondary (bottom)

Set the "VoltOhmyst" on the 10 volt scale.

Connect the meter in series with a one megohm resistor to the junction of diode resistors R219 and R220. Do not remove the discriminator shield to make connections to R219 and R220. Connection can be easily made by fashioning a hook on the 1 meg resistor lead and making connection to the transformer lug "C" through the hole provided for the adjusting tool.

Adjust the primary of T113 (top) for maximum output on the meter.

Connect the "VoltOhmyst" to the junction of R236 and C205.

Adjust T113 secondary (bottom). It will be found that it is possible to produce a positive or negative voltage on the meter dependent upon this adjustment. Obviously to pass from a positive to a negative voltage, the voltage must go through zero. T113 (bottom) should be adjusted so that the meter indicates zero output as the voltage swings from positive to negative. This point will be called discriminator zero output.

Connect the sweep oscillator to the grid of the third sound i-f amplifier.

Adjust the sweep band width to approximately 1 mc. with the center frequency at approximately 21.25 and with an output of approximately 1 volt.

Connect the oscilloscope between R236 and C205.

The pattern obtained should be similar to that shown in Figure 18A. If it is not, adjust the T113 (top) until the wave form is symmetrical.

The peak to peak bandwidth of the discriminator should be approximately 350 kc. and it should be linear from 21.175 mc. to 21.325 mc.

SOUND I-F ALIGNMENT—

Connect the sweep oscillator to the second sound i-f amplifier grid.

Connect the oscilloscope to the third sound i-f grid return (terminal A T112) in series with a 33,000 ohm isolating resistor.

Insert a 21.25 mc. marker signal from the signal generator into the second sound i-f grid.

Adjust T112 (top and bottom) for maximum gain and symmetry about the 21.25 mc. marker. The pattern obtained should be similar to that shown in Figure 18B.

The output level from the sweep should be set to produce approximately .3 volt peak-to-peak at the third sound i-f grid return when the final touches on the above adjustment are made. It is necessary that the sweep output voltage should not exceed the specified values otherwise the response curve will be broadened, permitting slight misadjustment to pass unnoticed and possibly causing distortion on weak signals.

Connect the sweep and signal generator to the top end of the trap winding of T2 (on top of the chassis). Adjust T111 (top and bottom), for maximum gain and symmetry at 21.25 mc.

Reduce the sweep output for the final adjustments so that approximately .3 volt peak-to-peak is present at the third sound i-f grid return.

The band width at 70% response from the first sound i-f grid to the third i-f grid should be approximately 200 kc.

R-F AND CONVERTER LINE ADJUSTMENT—

Connect the r-f sweep oscillator to the receiver antenna terminals, J103. If the sweep oscillator has a 50 ohm single-ended output, it will be necessary to obtain balanced output by properly terminating the sweep output cable and connecting a 120 ohm non-inductive resistor in series between the sweep output cable and each receiver antenna terminal as shown in Figure 12.

Connect the oscilloscope to the junction of L80 and R6 (in the r-f tuning unit) through a 10,000 ohm resistor. This connection is available on a terminal lug through a hole in the side apron

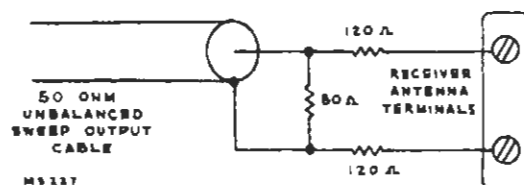


Figure 12—Unbalanced Sweep Cable Termination

of the chassis, beside the r-f unit. This hole is normally down when the chassis is in the recommended position. Connection can be easily made, however, by allowing the receiver to hang over the edge of the test bench by a few inches.

By-pass the first picture i-f grid to ground through a 1000 mmfd. capacitor. Keep the leads to this by-pass as short as possible. If this is not done, lead resonance may fall in the r-f range and cause an incorrect picture of the r-f response.

Set the picture control for approximately -1.5 volts bias on the r-f stage. (For convenience check this voltage at the diodes of V108, pins 5 and 6.)

Connect the signal generator loosely to the receiver antenna terminals.

Set the C14 adjustment screw to its approximate normal operating position, 1½ turns out from maximum capacity. If the C14 capacity is less than this it may produce a resonance in channel 1, 2 or 3. During r-f alignment, such a resonance may show up as a "suck out" in the response curve of one of these channels. Under such conditions it will be impossible to obtain the proper response. With C14 set as specified or in later production receivers in which C14 is fixed, no such difficulty should be experienced.

Since channel 7 has the narrowest response of any of the high frequency channels, it should be adjusted first.

Set the receiver channel switch to channel 7 (see Figure 17 for switch shaft flat location verses channel).

Set the sweep oscillator to cover channel 7.

Insert markers of channel 7 picture carrier and sound carrier 175.25 mc. and 179.75 mc.

Adjust L25, L26, L51 and L52, (see Figure 19), for an approximately flat topped response curve located symmetrically between the markers. Normally this curve appears somewhat overcoupled or double humped with a 10 or 15% peak to valley excursion and the markers occur at approximately 90% response. See Figure 19, channel 7. In making these adjustments, the stud extension of all cores should be kept approximately equal.

Check the response of channels 8 through 13 by switching the receiver channel switch, sweep oscillator and marker oscillator to each of these channels and observe the response obtained. See Figure 19 for typical response curves. It should be found that all these channels have the proper shaped response with the markers above 70% response. If the markers

ALIGNMENT PROCEDURE

630TS

do not fall within this requirement on one or more high frequency channels, since there are no individual channel adjustments, it will be necessary to readjust L25, L26, L51 and L52, and possibly compromise some channel slightly in order to get the markers up on other channels. Normally however, no difficulty of this type should be experienced since the higher frequency channels become comparatively broad and the markers easily fall within the required range.

Channel 6 is next aligned in the same manner.

Set the receiver to channel 6.

Set the sweep oscillator to cover channel 6.

Set the marker oscillator to channel 6 picture and sound carrier frequencies.

Adjust L11, L12, L37 and L38, for an approximately flat-topped response curve located symmetrically between the markers.

Check channels 5 down through channel 1 by switching the receiver, sweep oscillator and marker oscillator to each channel and observing the response obtained. In all cases, the markers should be above the 70% response point. If this is not the case, L11, L12, L37 and L38 should be retouched. On final adjustment, all channels must be within the 70% specification.

Coupling between r-f and converter lines is augmented by a link between L12 and L37. This link is adjusted in the factory and should not require adjustment in the field. On channel 6 with the link in the minimum coupling position, the response is slightly overcoupled with approximately a 10% excursion from peak-to-valley. With the coupling at maximum, the response is somewhat broader and the peak-to-valley excursion is approximately 40%. The amount of coupling permissible is limited by the peak-to-valley excursion which should not be greater than 30% on any channel.

R-F OSCILLATOR LINE ADJUSTMENT

The r-f oscillator line may be aligned by adjusting it to beat with a crystal calibrated heterodyne frequency meter, or by feeding a signal into the receiver at the r-f sound carrier frequency and adjusting the oscillator for zero output from the sound discriminator. In this latter case the sound discriminator must first have been aligned to exact frequency. Either method of adjustment will produce the same results. The method used will depend upon the type of test equipment available.

The heterodyne frequency meter is the more universal method since it is applicable to all types of receivers. However, it requires a great many calibration points since receivers with different i-f frequencies employ different oscillator frequencies and hence different calibration points on the frequency meter. This may result in confusion and errors in adjustment.

Since all sets must receive the same stations, the r-f sound carrier frequencies remain the same, regardless of i-f frequency. By use of this method, only one set of calibrating points is necessary. If these frequencies are crystal controlled, this method of alignment becomes very fast and with a mini-

mum chance for error. However, this method is applicable only on receivers that use a sound discriminator, or other type of sound detector that has a definite and measurable characteristic at center frequency. This method cannot be easily employed on receivers that employ a slope type detector.

Regardless of which method of oscillator alignment is used, the frequency standard must be crystal controlled or calibrated.

If the receiver oscillator is to be adjusted by the heterodyne frequency meter method, the following calibration points must be established for the 630TS.

Channel Number	Receiver R-F Osc. Freq. Mc.
1	71
2	81
3	87
4	93
5	103
6	109
7	201
8	207
9	213
10	219
11	225
12	231
13	237

If the receiver oscillator is adjusted by feeding in the r-f sound carrier frequency, the following signals must be available.

Channel Number	R-F Sound Carrier Freq. Mc.
1	49.75
2	59.75
3	65.75
4	71.75
5	81.75
6	87.75
7	179.75
8	185.75
9	191.75
10	197.75
11	203.75
12	209.75
13	215.75

If the heterodyne frequency meter method is used, couple the meter probe loosely to the receiver oscillator.

If the r-f sound carrier method is used, connect the VoltOhmyst to the sound discriminator output (junction of R236 and C205).

Connect the signal generator to the receiver antenna terminals.

The order of alignment remains the same regardless of which method is used.

630TS

ALIGNMENT PROCEDURE

Since lower frequencies are obtained by adding steps of inductance, it is necessary to align channel 13 first and continue in reverse numerical order.

Set the receiver channel switch to channel 13.

Adjust the frequency standard to the correct frequency (237 mc. for heterodyne frequency meter or 215.75 mc. for the signal generator).

Set the fine tuning control to the middle of its range while making the adjustment.

Adjust L77 and L78 for an audible beat on the heterodyne frequency meter or zero voltage from sound discriminator. The core stud extensions should be maintained equal by visual inspection except as discussed in the following paragraph entitled Oscillator Pulling.

Switch the receiver to channel 12.

Set the frequency standard to the proper frequency as listed in the alignment table.

Adjust L76 for indications as above.

Adjust the oscillator to frequency on all channels by switching the receiver and the frequency standard to each channel and adjusting the appropriate oscillator trimmer for the specified indication. It should be possible to adjust the oscillator to the correct frequency on all channels with the fine tuning control in the middle third of its range.

After the oscillator has been set on all channels, start back at channel 13 and recheck to make sure that all adjustments are correct.

Oscillator Pulling—If in setting the low frequency channels, the high frequency channels are pulled noticeably off frequency, or if it is impossible to set channels 10, 11 or 12 within the range of their respective trimmers, it may be due to interaction between sections of the line. A quick check can be made to determine if this is the case.

The shorting section of the r-f oscillator channel switch, (rotor), should be at ground r-f potential. If this is not the case due to dissymmetry in the circuit, the shorting section may be somewhat above ground. Since at these high frequencies, even the length of the shorting bar represents an appreciable portion of a wave length, the lower frequency section is effectively tapped up on the high frequency section and reflects reactance into it. This reactance varies with low frequency channel oscillator adjustments thus causing a shift in oscillator frequency on the upper channels. One way to cure this difficulty is to adjust the shorting switch to ground potential. This can be accomplished by staggering L77 and L78 until this condition is achieved.

To find if dissymmetry exists, remove the bottom cover from the r-f unit.

Set the channel switch to channel 10.

Disconnect any input from the receiver.

Connect the "VoltOhmyst" to R6 through the hole in the side of chassis, and measure the oscillator injection into the converter grid.

Take an insulated metal prod and touch the center of the oscillator rotor shorting bar. If the meter reading changes, it indicates that the bar is not at r-f ground.

To balance the line, switch to channel 13 and stagger the cores for one or more turns (usually L78 out and L77 in). The final adjustment must leave the oscillator on correct channel 13 frequency.

Switch back to channel 10 and touch the switch rotor as before. As before, meter movement indicates unbalance.

For fine balancing touch the switch contacts for channel 10. When balanced, the meter will show equal reduction for both contacts. Continue staggering the cores until balance is obtained.

Repeat the oscillator adjustments for all channels.

In later production receivers, several r-f oscillator coil changes were made and a capacitor C19 was added to minimize the oscillator pulling effect. In receivers in which C19 is present the staggering of cores should not be necessary.

CONVERTER GRID TRAP ADJUSTMENT—

Connect the sweep generator to the receiver antenna terminals. Observe the precaution for single-ended output generators mentioned in the r-f alignment section.

Connect the oscilloscope to R6 through 10,000 ohms.

Shunt the first picture i-f grid to ground with a 1,000 mmf. capacitor, keeping the leads as short as possible.

Couple the signal generator loosely to the receiver antenna terminals.

Switch the channel switch and signal generator through the low frequency channels and observe the response on each range.

Select a channel which is essentially flat over the operating range with the sound and picture carrier markers at 90% or higher on the response curve.

Remove the capacitor from the first picture i-f grid and shunt it from the second picture i-f grid to ground.

Adjust C14 for an r-f response curve similar to the one obtained with the first picture i-f grid shunted. See Figure 20.

In later production receivers, C14 is fixed and obviously this adjustment cannot be made on those sets. In such receivers, this step should be followed as a check to assure that proper converter operation is obtained.

RETOUCHING OF PICTURE I-F ADJUSTMENTS—

The picture i-f response curve varies somewhat with change of bias and for this reason it should be aligned with approximately the same signal input as it will receive in operation.

ALIGNMENT PROCEDURE

630TS

If the receiver is located at the edge of the service area, it should be aligned with the picture control at the maximum gain position. However, for normal conditions, (signals of 800 microvolts or greater), it is recommended that the picture i-f be aligned with a grid bias of -3 volts.

Connect the sweep generator to the receiver antenna terminals. Connect the signal generator to the antenna terminals and feed in the 25.75 mc i-f picture carrier marker and a 22.3 mc marker.

Connect the oscilloscope across the picture detector load resistor.

Remove the shunting capacitor from the second picture i-f grid. Set the i-f grid bias to -3 volts.

Set the sweep output to produce approximately .3 volt peak-to-peak across the picture detector load resistor.

Observe and analyze the response curve obtained. The response will not be ideal and the i-f adjustments must be retouched in order to obtain the desired curve. See Figure 21.

If for example as in Figure 21A the response is peaked in the middle, and the picture carrier is low on the response curve slope, then the high Q transformer T103, (which is peaked at 25.3 mc.--near the picture carrier 25.75 mc.), should be retouched to bring the picture carrier response up to approximately 40%.

It will then probably be found that the response is generally high on the low frequency end of the curve as in Figure 21B. If this is the case, adjust L183, (25.2 mc. and fairly broad), to bring the high frequency end response up. The picture carrier is thus brought still further up the slope and an approximately flat topped response curve is obtained as in Figure 21C.

If T104 (bottom) required any adjustment, it will be necessary to reset T104 (top) for minimum response at 19.75 mc.

On final adjustment the picture carrier marker must be at approximately 60% response. The curve must be approximately flat topped and with the 22.3 mc. marker at approximately 100% response.

The most important consideration in making the i-f adjustments is to get the picture carrier at the 60% response point. If the picture carrier operates too low on the response curve, loss of low frequency video response, of picture brilliance, of blanking, and of sync may occur. If the picture carrier operates too high on the response curve, the picture definition is impaired by loss of high frequency video response.

The above example is used to show the line of reasoning involved in making the retouching adjustments. Since there are five transformers each aligned to a different frequency, it is obvious that many different conditions can exist, however, similar reasoning will apply to each case. With some experience in making these adjustments, it will be found that the desired response can be readily obtained. In making

these adjustments, care should be taken that no two transformers are tuned to the same frequency as i-f oscillation may result.

SENSITIVITY CHECK—A comparative sensitivity check can be made by operating the receiver on a weak signal from a television station and comparing the picture and sound obtained to that obtained on other receivers under the same conditions.

This weak signal can be obtained by connecting the shop antenna to the receiver through an attenuator pad of the type shown in Figure 13. The number of stages in the pad depends upon the signal strength available at the antenna. A sufficient number of stages should be inserted so that a somewhat less than normal contrast picture is obtained when the picture control is at the maximum clockwise position.

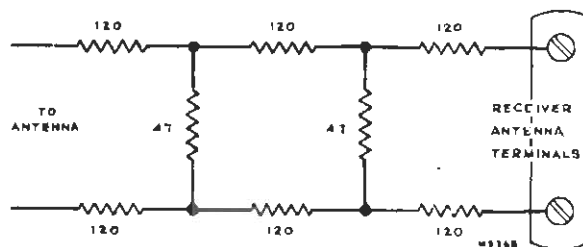


Figure 13—Attenuator Pad

Only carbon type resistors should be used to construct the attenuator pad. Since many of the low value moulded resistors generally available are of wire wound construction, it is advisable to break and examine one of each type of resistor used in order to determine its construction.

RESPONSE CURVES—The response curves shown on page 22 and referred to throughout the alignment procedure were taken from a production set. Although these curves are typical, some variations can be expected. On early production, channel 4, rf response is somewhat more narrow than that shown which is from later production. Channel 2 response (not shown) is similar to that of channel 3.

The response curves are shown in the classical manner of presentation, that is with "response up" and low frequency to the left. The manner in which they will be seen in a given test set-up will depend upon the characteristics of the oscilloscope and the sweep generator. The curves may be seen inverted and or switched from left to right depending on the deflection polarity of the oscilloscope and the phasing of the sweep generator.

ALIGNMENT TABLE—Both methods of oscillator alignment are presented in the alignment table. The service technician may thereby choose the method to suit his test equipment. If it is found that the dual listing is confusing, the unwanted listing can be easily erased.

630TS

ALIGNMENT TABLE

The detailed alignment procedure beginning on page 14 should be read before alignment by use of the table is attempted.

STEP No.	CONNECT SIGNAL GENERATOR TO	SIGNAL GEN. FREQ. MC.	CONNECT SWEEP GENERATOR TO	SWEEP GEN. FREQ. MC.	CONNECT OSCILLOSCOPE TO	CONNECT "VOLTOHMYST" TO	MISCELLANEOUS CONNECTIONS AND INSTRUCTIONS	ADJUST	REFER TO
PICTURE I-F AND TRAP ADJUSTMENT									
1	Not used		Not used		Not used	Junction of R189 & R190		Picture control for .3 volts on meter	Fig. 16
2	Antenna terminal	19.75	"		"	Junction of L188 & R137	Meter on 3 volt scale	T104 (top) for min. on meter	Fig. 16 Fig. 14
3	"	21.25	"		"	"	"	T2 (top) for min.	Fig. 14
4	"	21.25	"		"	"	"	T105 (top) for min.	"
5	"	27.25	"		"	"	"	T103 (top) for min.	"
6	"	21.8	"		"	"	"	T2 (bottom) for max.	Fig. 15
7	"	25.3	"		"	"	"	T103 (bottom) for max.	"
8	"	22.3	"		"	"	"	T104 (bottom) for max.	"
9	"	25.2	"		"	"	"	L183 (top chassis) for max.	Fig. 14
10	"	23.4	"		"	"	"	L185 (top chassis) for max.	"
11	If T104 (bottom) required adjustment in step 8, repeat step 2.								
DISCRIMINATOR AND SOUND I-F ALIGNMENT									
12	3rd sound i-f grid (pin 1, V106)	21.25 1 volt output	Not used		Not used	In series with 1 meg. to junction of R219 & R220		Detune T113 (bottom). Adjust T113 (top) for max. on meter	Fig. 16 Fig. 15 Fig. 14
13	"	"	"		"	Junction of R236 & C205	Meter on 3 volt scale	T113 (bottom) for zero on meter	Fig. 16 Fig. 15
14	"	"	3rd sound i-f grid (pin 1, V106)	21.25 center 1 mc. wide 1 v. out	Junction of R236 & C205	Not used	Check for symmetrical response waveform (positive & negative). If not equal adjust T113 (top) until they are equal		Fig. 16 Fig. 18 A
15	2nd sound i-f grid (pin 1, V105)	21.25 reduced output	2nd sound i-f grid	21.25 reduced output	Terminal A, T112 in series with 33,000 ohms	"	Sweep output reduced to provide .3 volt p-to-p on scope	T112 (top & bottom) for max. gain and symmetry at 21.25 mc.	Fig. 16 Fig. 14 Fig. 15 Fig. 18 B
16	Trap winding on T2 (top of chassis)	21.25 reduced output	Trap winding on T2	21.25 reduced output	"	"	"	T111 (top & bottom) for max. gain and symmetry at 21.25 mc.	Fig. 14 Fig. 15 Fig. 16 Fig. 18 B
R-F AND CONVERTER LINE ALIGNMENT									
17	Not used		Not used		Not used	Pin 5 or 6, V108	Set C14 1 1/2 turns out from max. cap.	Picture control for 1.5 volts on meter	Fig. 16 Fig. 15
18	Antenna terminal (loosely)	175.25 & 179.75	Antenna terminals (see text for precaution)	Sweeping channel 7	Junction L80 and R6 through 10,000 ohm series resistor	Not used	1st i-f grid bypass to gnd. with 1000 mmf. Receiver on channel 7	L25, L26, L51 & L52 for approx. flat top response between markers. Markers above 70%	Fig. 16 Fig. 15 Fig. 19 (7)
19	"	181.25 185.75	"	channel 8	"	"	Receiver on channel 8	Check to see that response is as above	Fig. 19 (8)
20	"	187.25 191.75	"	channel 9	"	"	Receiver on channel 9	"	Fig. 19 (9)
21	"	193.25 197.75	"	channel 10	"	"	Receiver on channel 10	"	Fig. 19 (10)
22	"	199.25 203.75	"	channel 11	"	"	Receiver on channel 11	"	Fig. 19 (11)
23	"	205.25 209.75	"	channel 12	"	"	Receiver on channel 12	"	Fig. 19 (12)
24	"	211.25 215.75	"	channel 13	"	"	Receiver on channel 13	"	Fig. 19 (13)
25	If the response on any channel (steps 19 through 24) is below 70% at either marker, switch to that channel and adjust L25, L26, L51 & L52 to pull response up on that channel. Then recheck steps 18 through 24.								

ALIGNMENT TABLE

630TS

STEP No.	CONNECT SIGNAL GENERATOR TO	SIGNAL GEN. FREQ. MC.	CONNECT SWEEP GENERATOR TO	SWEEP GEN. FREQ. MC.	CONNECT OSCILLOSCOPE TO	CONNECT "VOLTOHMYST" TO	MISCELLANEOUS CONNECTIONS AND INSTRUCTIONS	ADJUST	REFER TO
R-F AND CONVERTER LINE ALIGNMENT (Cont'd)									
26	Antenna terminal (loosely)	83.25 87.75	Antenna terminals (see text for precaution)	Sweeping channel 6	Junction L80 and R6 through 10,000 ohm series resistor	Not used	Receiver on channel 6	L11, L12, L37 & L38 for response as above	Fig. 19 (8)
27	"	77.25 81.75	"	channel 5	"	"	Receiver on channel 5	Check to see that response is as above	Fig. 19 (5)
28	"	67.25 71.75	"	channel 4	"	"	Receiver on channel 4	"	Fig. 19 (4)
29	"	61.25 65.75	"	channel 3	"	"	Receiver on channel 3	"	Fig. 19 (3)
30	"	55.25 59.75	"	channel 2	"	"	Receiver on channel 2	"	"
31	"	45.25 49.75	"	channel 1	"	"	Receiver on channel 1	"	Fig. 19 (1)
32	If the response on any channel (steps 27 through 31) is below 70% at either marker, switch to that channel and adjust L11, L12, L37 & L38 to pull response up on that channel. Then recheck steps 26 through 31.								
R-F OSCILLATOR ALIGNMENT									
STEP No.	CONNECT SIGNAL GENERATOR TO	SIGNAL GEN. FREQ. MC.	CONNECT HETERODYNE FREQ. METER TO	HET. METER FREQ. MC.	CONNECT OSCILLOSCOPE TO	CONNECT "VOLTOHMYST" TO	MISCELLANEOUS CONNECTIONS AND INSTRUCTIONS	ADJUST	REFER TO
33	Antenna terminals	215.75	Loosely coupled to r-f osc.	237	Not used	Junction of R236 & C205 for sig. gen. method only	Fine tuning centered for all adjustments Receiver on channel 13	L77 & L78 for zero on meter or beat on het. freq. meter	Fig. 16 Fig. 15
34	"	209.75	"	231	"	"	Receiver on channel 12	L76 as above	Fig. 17
35	"	203.75	"	225	"	"	Receiver on channel 11	L74 as above	"
36	"	197.75	"	219	"	"	Receiver on channel 10	L72 as above	"
37	"	191.75	"	213	"	"	Receiver on channel 9	L70 as above	"
38	"	185.75	"	207	"	"	Receiver on channel 8	L68 as above	"
39	"	179.75	"	201	"	"	Receiver on channel 7	L66 as above	"
40	"	87.75	"	109	"	"	Receiver on channel 6	L63 & L64 as above	Fig. 15
41	"	81.75	"	103	"	"	Receiver on channel 5	L62 as above	Fig. 17
42	"	71.75	"	93	"	"	Receiver on channel 4	L60 as above	"
43	"	65.75	"	87	"	"	Receiver on channel 3	L58 as above	"
44	"	59.75	"	81	"	"	Receiver on channel 2	L56 as above	"
45	"	49.75	"	71	"	"	Receiver on channel 1	L54 as above	"
46	Repeat steps 33 through 45 as a check.								
CONVERTER GRID TRAP ADJUSTMENT									
47	Antenna terminal (loosely)	Sound and Pix Carrier of Selected Channel	Not used		Junction L80 and R6 (in r-f unit)	Not used	Connect sweep to ant. terms. 1st pix i-f grid bypassed to gnd. with 1000 mmf.	Switch through channels 1 through 6. Select channel with flat response and markers above 80%	Fig. 16 Fig. 20 (A)
48	"	"	"		"	"	Move 1000 mmf bypass from 1st pix i-f grid to 2 i-f grid	Adjust C14 for response curve similar to that obtained above	Fig. 16 Fig. 20 (B)
RETOUCHING PICTURE I-F TRANSFORMERS									
49			Not used		Not used	Junction of R189 & R190	Receiver & sweep on same channel as above. Remove i-f grid bypass	Adjust picture control for -3 volts on meter	Fig. 16
50	Antenna terminals (loosely)	22.3 25.75	"		Junction L188 and R137	Not used	Retouch pix i-f adjustment (T2, T103, T104 bottoms L183 & L185, as necessary to provide proper response		Fig. 16 Fig. 15 Fig. 21
51	If T104 (bottom) was adjusted in step 50, repeat step 2 and step 50.								
SENSITIVITY CHECK									
52	Connect antenna to receiver through attenuator pad to provide weak signal. Compare picture and sound obtained to that obtained on other receivers under the same conditions.								

INSTALLATION INSTRUCTIONS

630TS

RECEIVER HANDLING PRECAUTION—The 630TS Receiver weighs approximately 85 pounds and therefore should always be picked up from under the bottom of the cabinet since lifting by the top would tend to pull the cabinet apart.

The receiver is shipped with all tubes in their sockets except the 10BP4 Kinescope. The Kinescope is shipped in a special carton and should not be unpacked until ready for installation.

SETTING UP THE RECEIVER—Remove the top of the receiver cabinet as indicated in Figure 22. Install the front panel control knobs. Make sure that all tubes are in place and firmly seated in their sockets. Remove the protective cardboard shield from the 5U4G rectifier tube.

TO REMOVE CABINET TOP, TAKE OUT THESE SCREWS & SLIDE TOP BACK

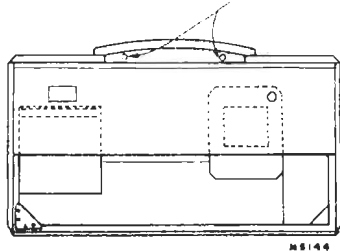


Figure 22—Cabinet, Rear View

Loosen the two kinescope cushion adjustment wing screws and slide the cushion towards the rear of the chassis. Loosen the deflection yoke adjustment, slide the yoke toward the rear of the chassis and tighten. See Figure 23 for the location of the cushion and yoke adjustments.

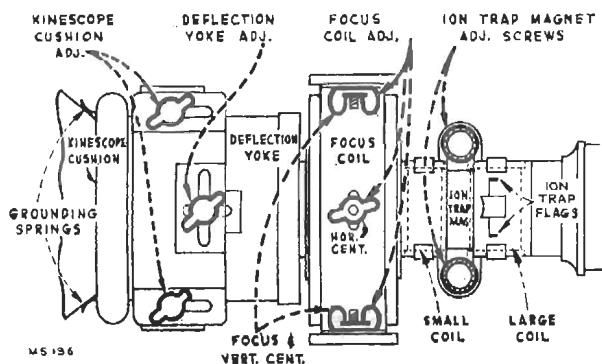


Figure 23—Yoke and Focus Coil Adjustments

From the front of the cabinet, look through the deflection yoke and check the alignment of the focus coil with the yoke. If the focus coil is not in line, loosen the three focus coil adjustment wingnuts and raise lower or rotate the coil until such an alignment is obtained. Tighten the wingnuts with the coil in this position.

Loosen the two lower Kinescope face centering slides, and set them at approximately mid position. See Figure 24 for location of the slides and their adjustment screws. Loosen the ion trap magnet adjustment thumb screws.

KINESCOPE HANDLING PRECAUTION—Do not open the Kinescope shipping carton, install, remove, or handle the Kinescope in any manner, unless shatterproof goggles and heavy gloves are worn. People not so equipped should be kept away while handling the Kinescope. Keep the Kinescope away from the body while handling. The shipping carton should be kept for use in case of future moves.

TO INSTALL CABINET FRONT PANEL INSERT THESE SCREWS INSIDE CABINET.

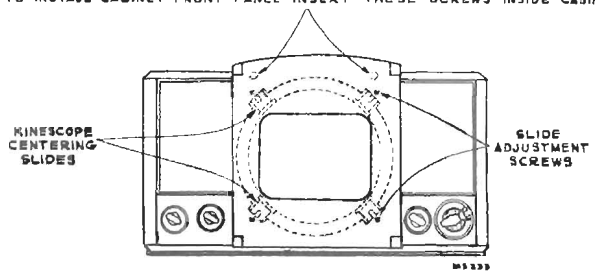


Figure 24—Cabinet, Front View

INSTALLATION OF KINESCOPE—The Kinescope second anode contact is a recessed metal well in the side of the bulb. The tube must be installed so that this contact is approximately on top. The final orientation of the tube will be determined by the position of the ion trap flags. Looking at the Kinescope gun structure, it will be observed that the second cylinder from the base inside the glass neck, is provided with two small metal flags, as shown in Figure 25. The Kinescope must be installed so that when looking down on the chassis, the two flags will be seen as shown in Figure 23.

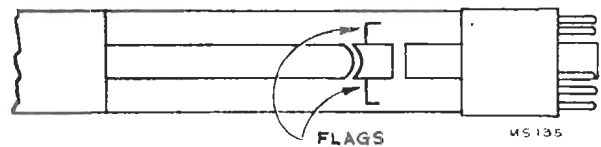


Figure 25—Ion Trap Flags

Insert the neck of the kinescope through the deflection and focus coils as shown in Figure 26 until the base of the tube protrudes approximately two inches beyond the focus coil. If the tube sticks, or fails to slip into place smoothly, investigate and remove the cause of the trouble. Do not force the tube.

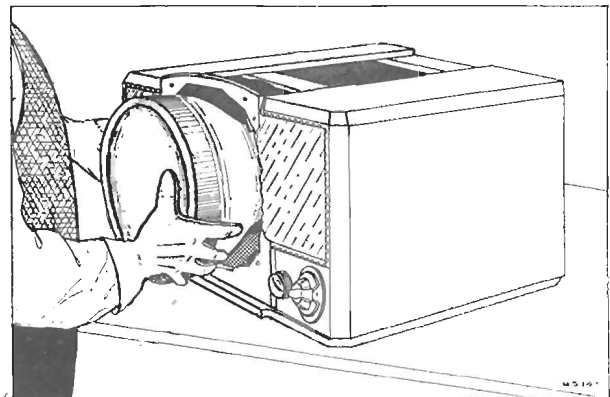


Figure 26—Kinescope Insertion

Slip the ion trap magnet on the neck of the Kinescope with the large coil toward the base of the tube as shown in Figure 23. Connect the Kinescope socket to the tube base. Insert the Kinescope until the face of the tube protrudes approximately one-quarter of an inch outside the front of the cabinet.

Adjust the four centering slides until the face of the Kinescope is in the center of the cabinet opening. Tighten the four slides securely.

Wipe the Kinescope screen surface and front panel safety glass clean of all dust and finger marks with a soft cloth moistened with "Windex" or similar cleaning agent.

Install the cabinet front as indicated in Figure 24.

Slip the Kinescope as far forward as possible. Slide the Kinescope cushion firmly up against the flare of the tube and tighten the adjustment wing screws. Slide the deflection yoke as far forward as possible. Connect the high voltage lead to the Kinescope second anode socket.

The antenna and power connections should now be made. Turn the power switch to the "on" position, the brightness control fully clockwise, and picture control counter-clockwise.

ION TRAP MAGNET ADJUSTMENT—The rear ion trap magnet poles should be approximately over the ion trap flags as shown in Figure 23. Starting from this position adjust the magnet by moving it forward or backward at the same time rotating it slightly around the neck of the Kinescope for the brightest raster on the screen. Tighten the magnet adjustment thumb-screws sufficiently to hold it in this position but still free enough to permit further adjustment. Reduce the brightness control setting until the raster is slightly above average brilliance. Adjust the focus control (R184 on the chassis rear apron) until the line structure of the raster is clearly visible. Readjust the ion trap magnet for maximum raster brilliance. The final touches on this adjustment should be made with the brightness control at the maximum position with which good line focus can be maintained.

FOCUS COIL ADJUSTMENTS—Turn the centering controls R181 and R211 to mid position. See Figure 27 for location of these rear apron controls.

If a corner of the raster is shadowed, it indicates that the electron beam is striking the neck of the tube. Loosen the focus coil adjustment wing nuts and rotate the coil about its vertical and horizontal axis until the entire raster is visible, approximately centered and with no shadowed corners. Tighten the focus coil adjustment wing nuts with the coil in this position.

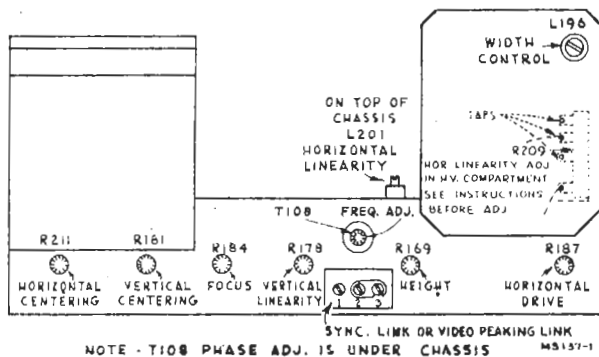


Figure 27—Rear Chassis Adjustments

DEFLECTION YOKE ADJUSTMENT—If the lines of the raster are not horizontal or squared with the picture mask, rotate the deflection yoke until this condition is obtained. Tighten the yoke adjustment wing screw.

PICTURE ADJUSTMENTS—It will now be necessary to obtain a test pattern picture in order to make further adjustments. See Step 2 through 9 and the note of the receiver operating instructions on page 3.

CHECK OF LINK CONNECTION—In early receivers, the link board J102 was connected to the horizontal oscillator control tube. In late production, the link was employed to provide optional video peaking. See page 9 for a description of the functions of the link. In order to determine which type of connection is employed in a particular set, touch the finger to terminal #3. If the picture is displaced horizontally the

board is connected to the oscillator. Little or no effect may be noticed if the board is connected to the video stage.

CHECK OF HORIZONTAL OSCILLATOR ALIGNMENT—If the board was found to be connected to the control tube in the above test, set the link in the normal position (2 to 3). Turn the horizontal hold control to the extreme counter-clockwise position. The picture should remain in horizontal sync. Momentarily remove the signal by turning the picture control fully counter-clockwise and then returning it to the operating position. Normally the picture will pull into sync.

Turn the horizontal hold control to the extreme clockwise position. The picture should remain in sync. Momentarily remove the signal. Again the picture should normally pull into sync.

If the receiver passes the above checks and the picture is normal and stable, the horizontal oscillator is properly aligned. Skip "Alignment of Horizontal Oscillator and proceed with 'FOCUS' adjustments."

ALIGNMENT OF HORIZONTAL OSCILLATOR—If in the above check the receiver failed to hold sync with the hold control at either extreme or failed to pull into sync after momentary removals of the signal, make the adjustments under "Slight Retouching Adjustments." If, after making these retouching adjustments, the receiver fails to pass the above checks or if the horizontal oscillator is completely out of adjustment, then make the adjustments under "Complete Realignment."

Slight Retouching Adjustments—Tune in a Television Station and adjust the fine tuning control for best sound quality. Sync the picture and adjust the picture control for slightly less than normal contrast. Turn the horizontal hold control to the extreme position in which the oscillator fails to hold or to pull in. Momentarily remove the signal. Turn the T108 frequency adjustment on the chassis rear apron until the oscillator pulls into sync. Check hold and pull-in for the other extreme position of the hold control.

Complete Realignment—Tune in a Television Station and adjust the fine tuning control for best sound quality.

Turn the T108 frequency adjustment (on rear apron), until the picture is synchronized. (If the picture is not synchronized vertically, adjust the vertical hold.) Adjust the picture control so that the picture is somewhat below average contrast level. Turn the T108 phase adjustment screw (under chassis, see Figure 11) until the blanking bar, which may appear in the picture moves to the right and off the raster. The range of this adjustment is such that it is possible to hit an unstable condition (ripples in the raster). The screw must be turned clockwise from the unstable position. The length of stud beyond the bushing in its correct position is usually about 1/2 inch.

Turn horizontal hold to extreme counter-clockwise position. Turn T108 frequency adjustment clockwise until the picture falls out of sync. Then turn it slowly counter-clockwise to the point where the picture falls in sync again.

Readjust T108 phase adjustment so that the left side of the picture is close to the left side of the raster, but does not begin to fold over.

Turn horizontal hold to extreme clockwise. The right side of the picture should be close to the right side of the raster, but should not begin to fold over. If it does, readjust the phase. Momentarily remove the signal. When the signal is restored, the picture should fall in sync. If it doesn't, turn T108 frequency adjustment counter-clockwise until the picture falls in sync.

Turn horizontal hold to extreme counter-clockwise position. Remove the signal momentarily. When signal is restored, the picture should fall in sync.

INSTALLATION INSTRUCTIONS

630TS

the pull-in range may be inadequate, though not necessarily. A pull-in through $\frac{3}{4}$ of the hold control range may still be satisfactory.

There is a difference between the pull-in range and hold-in range of frequencies. Once in sync, the circuit will hold about 50% to 100% more variation in frequency than it can pull in. The range of the horizontal hold control is only approximately equal to the pull-in range, considerable variation may be found due to variations in the cut-off characteristic of the horizontal oscillator control tubes, V124.

Excessive pull-in is objectionable because the higher sensitivity of the control circuits means also greater susceptibility to noise, and to the vertical sync and equalizing pulses which tend to cause a bend in the upper part of the raster. This effect is more noticeable when the sync link is in the 1-2 position.

FOCUS—A slightly better average focus may be obtained by sliding the focus coil back and forth along the Kinescope neck while adjusting the focus control and watching the test pattern. The final adjustment of the focus coil should leave the raster approximately centered.

HEIGHT AND VERTICAL LINEARITY ADJUSTMENTS—Adjust the height control (R169 on chassis rear apron) until the picture fills the mask vertically ($6\frac{3}{8}$ inches). Adjust vertical linearity (R178 on rear apron), until the test pattern is symmetrical from top to bottom. Adjustment of either control will require a readjustment of the other. Adjust vertical centering to align the picture with the mask.

WIDTH AND HORIZONTAL LINEARITY ADJUSTMENTS—Turn the horizontal drive (R187 on rear apron) clockwise as far as possible without causing crowding of the right of the picture. This position provides maximum high voltage to the Kinescope second anode. Adjust the width control (L196 on rear chassis) until the picture just fills the mask horizontally ($8\frac{1}{2}$ inches). Adjust the horizontal linearity control L201 (see Figure 27) until the test pattern is symmetrical left to right. A slight readjustment of the horizontal drive control may be necessary when the linearity control is used. Adjust horizontal centering to align the picture with the mask.

If repeated adjustments of drive width and linearity fail to give proper linearity, it may be necessary to move the tap on R209, which is located in the high voltage compartment. Adjustments of drive, width and linearity must then be repeated.

Check to see that all cushion, yoke, focus coil and ion trap thumb screws are tight. Replace the cabinet top.

CHECK OF R-F OSCILLATOR ADJUSTMENTS—With a crystal calibrated test oscillator or heterodyne frequency meter, check to see if the receiver r-f oscillator is adjusted to the proper frequency on all channels. If adjustments are required, these should be made by the method outlined in the alignment procedure on page 21. The adjustments for channels 1 through 5 and 7 through 12 are available from the front of the cabinet by removing the station selector escutcheon as shown in Figure 28. Adjustments for channels 6 and 13 are under the chassis. See Figure 15 for their location.

Tune in all available Television Stations. Observe the picture for detail, for proper interlacing and for the presence of interference or reflections. If these are encountered, see the section on antennas on page 26.

INSTALLATION INSTRUCTION TABLE

Step No.	Proceed as Indicated
1	Remove receiver cabinet top. Install knobs.
2	Make sure all tubes are firmly seated in their sockets.
3	Remove cardboard shield from rectifier tube.
4	Slide Kinescope cushion toward rear of chassis.
5	Slide deflection yoke toward rear of chassis—tighten.
6	Align focus coil with yoke—tighten.
7	Set lower Kinescope centering slides to mid-position.
8	Loosen ion trap adjustment thumbscrews.
9	Insert Kinescope until base protrudes two inches beyond focus coil.
10	Slip ion trap on Kinescope neck, large coil to rear. Install Kinescope socket.
11	Insert Kinescope until face protrudes one-quarter inch outside cabinet front.
12	Adjust all four Kinescope centering slides—tighten.
13	Wipe Kinescope face and front panel safety glass.
14	Install cabinet front panel.
15	Slip Kinescope forward, slip cushion forward—tighten.
16	Slip deflection yoke forward.
17	Connect Kinescope high voltage lead.
18	Connect receiver to a-c line and antenna.
19	Turn receiver on, brightness fully clockwise, picture counterclockwise.
20	Adjust ion trap for bright raster.
21	Reduce brightness, adjust focus control R184 for visible line structure.
22	Adjust ion trap and brightness control for brightest raster with which line focus can be maintained.
23	Set centering controls R181 and R211 to mid-position.
24	Adjust focus coil for non-shadowed raster approx. centered.
25	Adjust yoke to orient raster with picture mask—tighten.
26	Tune in station per operating instructions—steps 2 through 9.
27	Check horizontal oscillator for hold and pull-in with horizontal hold control at each extreme.
28	Align horizontal oscillator (T108) if necessary.
29	Adjust focus coil and focus control.
30	Adjust height and vertical linearity and vertical centering controls.
31	Adjust width, horizontal drive, linearity and horizontal centering controls.
32	MAKE SURE ALL ADJUSTMENTS ARE TIGHT.
33	Replace cabinet top.
34	Check r-f oscillator frequency on all channels.
35	Observe picture from all available stations.

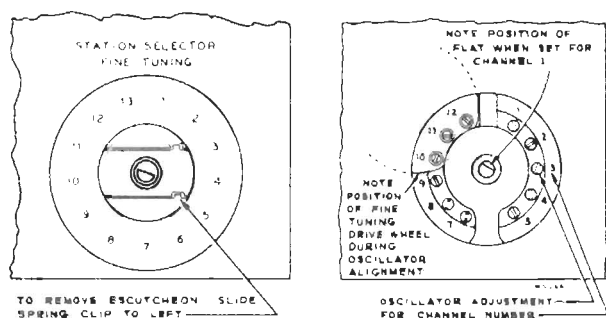


Figure 28—R-F Oscillator Adjustments

VENTILATION CAUTION—The receiver is provided with adequate ventilation holes in the bottom, back and top of the cabinet. Care should be taken not to allow these holes to be covered or ventilation impeded in any way.

ANTENNAS—The finest television receiver built may be said to be only as good as the antenna design and installation. It is therefore important to use a correctly designed antenna, and use care in its installation.

REFLECTIONS If reflections are encountered, it may be possible to eliminate them by rotation of the antenna. A shift of direction or a few feet in antenna position may effect a tremendous difference in picture reception.

Occasionally reflections may occur that are not noticeable as reflections but that will instead cause a loss of definition in the picture.

INTERFERENCE—Auto ignition, street cars, electrical machinery and diathermy apparatus may cause noise interference which spoils the picture. Whenever possible, the antenna location should be removed as far as possible from highways, hospitals, doctors' offices and similar sources of interference. In mounting the antenna, care must be taken to keep the antenna rods at least $\frac{1}{4}$ wave length (at least 6 feet) away from other antennas, metal roofs, gutters or other metal objects.

INFORMATION REFERENCES— For further information on antennas and antenna installation see RCA Booklet entitled "Practical Television by RCA," and also the specific instructions accompanying the RCA Television Antenna.

SERVICE SUGGESTIONS

Following is a list of symptoms of possible failures and an indication of some of the possible faults.

NO RASTER ON KINESCOPE:

- (1) Incorrect adjustment of ion trap magnet—Coils reversed either front to back or top to bottom, ion trap magnet coil open.
- (2) V126 or V127 inoperative—check voltage and waveform on grids and plates.
- (3) No high voltage—If horizontal deflection is operating as evidenced by the correct waveform on terminal 4 of horizontal output transformer, the trouble can be isolated to the 8016 circuit. Either the T109 high voltage winding is open, (points 2 to 3), the 8016 tube is defective, its filament circuit is open, C187 is shorted, R233 or R235 open.

- (4) V125 and V120-B circuits inoperative—check for sine wave on V125 grid, pulse on V120-B grid, and sawtooth on V126 grid. Refer to schematic and wave form chart.

- (5) Reaction scanning tube (V128) inoperative.

- (6) Defective Kinescope.

- (7) R152 open, (terminal 3 to ground).

- (8) No receiver plate voltage—filter capacitor or speaker field shorted—negative bleeder or speaker field open.

NO VERTICAL DEFLECTION:

- (1) V121 or V122 inoperative. Check voltage and wave forms on grids and plates.
- (2) T107 open.
- (3) Vertical deflection coils open.

NO HORIZONTAL DEFLECTION:

- (1) V125, V120B, V126 or V128 inoperative—check voltage and wave forms on grids and plate.
- (2) T109 open.
- (3) Horizontal deflection coil open.

SMALL RASTER:

- (1) Low Plus B or low line voltage.

POOR VERTICAL LINEARITY:

- (1) If adjustments cannot correct, change V122.
- (2) Vertical output transformer defective.
- (3) V121 inoperative—check voltage and wave forms on grid and plate.
- (4) R174, C158, C221-C or C222-B defective.
- (5) Low bias or plate voltage—check rectifiers and capacitors in supply circuits.

POOR HORIZONTAL LINEARITY:

- (1) If adjustments do not correct, change V128 or V126.
- (2) T109 or L201 defective.
- (3) C186 or C188 or R209 defective.
- (4) C179, R187 or R210 defective.

PICTURE OUT OF PHASE HORIZONTALLY:

- (1) T108 winding D to F incorrectly tuned or connected in reverse.
- (2) R200 or R202 defective.

SERVICE SUGGESTIONS

630TS

TRAPEZOIDAL OR NON-SYMMETRICAL RASTER:

- (1) Improper adjustment of focus coil or ion trap magnet.
- (2) Defective yoke.

RASTER & SIGNAL ON KINESCOPE BUT NO SOUND:

- (1) R-F oscillator off frequency.
- (2) Sound i-f, discriminator or audio amplifier inoperative—check V104, V105, V106, V107, V108, V109 and their socket voltages.
- (3) T114 or C209 defective.
- (4) Speaker defective.

SIGNAL AT KINESCOPE GRID BUT NO SYNC:

- (1) Picture control advanced too far.
- (2) V114-B, V118, V119, or V120-A inoperative. Check voltage and waveforms at their grids and plates.
- (3) C142 defective.

SIGNAL ON KINESCOPE GRID BUT NO VERTICAL SYNC:

- (1) Check V121 and associated circuit—C154, T106, etc.
- (2) Integrating network inoperative—Check C149, C151, C152, C153, R162, R163, R164 and R165.

SIGNAL ON KINESCOPE GRID BUT NO HORIZONTAL SYNC:

- (1) T108 misadjusted—readjust as instructed on page 24.
- (2) V123 or V124 inoperative—check socket voltages and waveforms.
- (3) T108 defective.
- (4) C166, C167, C170 or C171 defective.
- (5) If horizontal speed is completely off and cannot be adjusted check C168, C169, R168 and R196.

PICTURE STABLE BUT POOR RESOLUTION:

- (1) V114, V115 or V116 defective.
- (2) Peaking coils defective—check for specified resistance.
- (3) C138, C140, C141 or C142 defective.
- (4) Make sure that the focus control operates on both sides of proper focus.
- (5) R-F and I-F circuits misaligned.

PICTURE SMEAR:

- (1) Video amplifier overloaded by excessive input—reduce picture control setting.
- (2) Insufficient bias on V115 and V116 resulting in grid current on video signal. Check bias and possible grid current.
- (3) Defective coupling condenser or grid load resistor—check C138, C140, C141, C223B, R138, R142, R143, R148, etc.
- (4) This trouble can originate at the transmitter—check on another station.

PICTURE JITTER:

- (1) Picture control operated at excessive level.
- (2) If regular sections at the left picture are displaced change V126.
- (3) Vertical instability may be due to loose connections or noise.
- (4) Horizontal instability may be due to unstable transmitted sync. Connect sync link to terminal 1 and 2.

SOUND & RASTER BUT NO PICTURE OR SYNC:

- (1) Picture i-f, detector or video amplifier inoperative—check V110, V111, V112, V113, V114, V115 and V116—check socket voltages.
- (2) Bad contact to Kinescope grid.

RASTER BUT NO SOUND, PICTURE OR SYNC:

- (1) Defective antenna or transmission line.
- (2) R-F oscillator off frequency.
- (3) R-F unit inoperative—Check V1, V2, V3 and their socket voltages.

DARK VERTICAL LINE ON LEFT OF PICTURE:

- (1) Reduce horizontal drive and readjust width and horizontal linearity.
- (2) Replace V126.

LIGHT VERTICAL LINE ON LEFT OF PICTURE:

- (1) C181 defective.
- (2) V128 defective.
- (3) Change tap on R209.

CRITICAL LEAD DRESS:

1. Dress spaghetti-covered leads from A and B on discriminator transformer T113 to pin 7 and 2 on V107 tube socket approximately $\frac{3}{16}$ " above chassis.
2. Dress video capacitors C-138, C-140 and C-141 up and away from chassis.
3. Dress video peaking coils L-187, L-188, L-189, L-190, L-191 and L-192 up and away from chassis.
4. Contact between the r-f oscillator frequency adjustment screws and the oscillator coils or channel switch eyelets must be avoided.
5. Dress leads from L196 (width control coil) away from the lead to the cap of V127 (h-v rectifier). Contact between these leads will cause arcing and fire.
6. Dress T109 winding leads as shown in Figure 29.

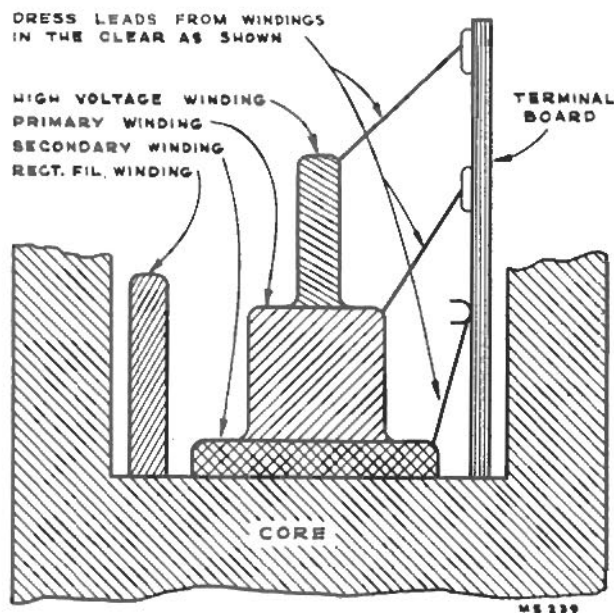


Figure 29—T109 Lead Dress

PICTURE I-F RESPONSE—At times it may be desirable to observe the individual i-f stage response. This can be achieved by the following method.

Select a channel with a flat r-f response as outlined in the converter grid trap adjustment section of the alignment procedure.

Shunt all i-f transformers and coils with a 330 ohm carbon resistor except the one whose response is to be observed.

Connect the oscilloscope across the picture detector load resistor and observe the overall response. The response obtained will be essentially that of the unshunted stage. The effects of the various traps are also visible on the stage response.

Figures 54 through 58 show the response of the various stages obtained in the above manner. The curves shown are typical although some variation between receivers can be expected. Relative stage gain is not shown.

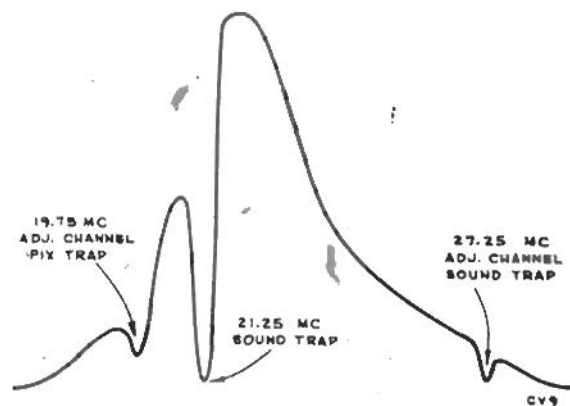


Figure 30—T2 Response

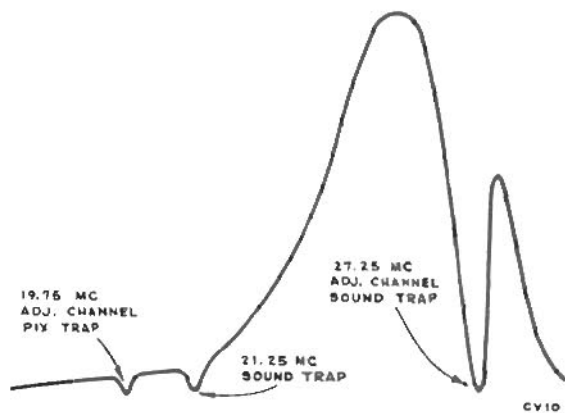


Figure 31—T103 Response

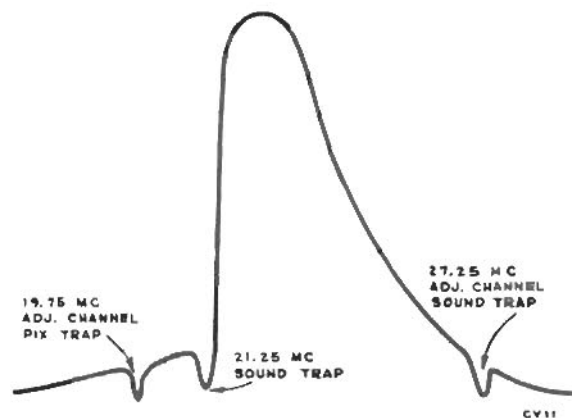


Figure 32—T104 Response

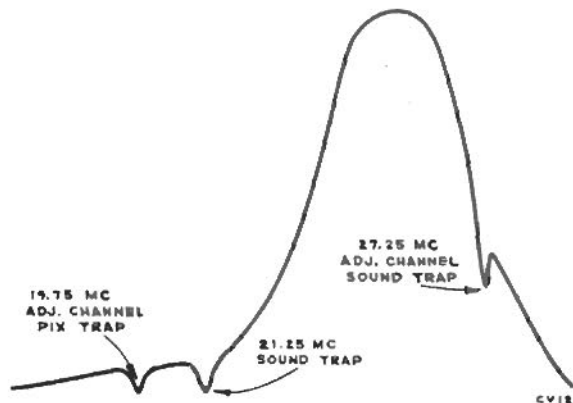


Figure 33—L183 Response

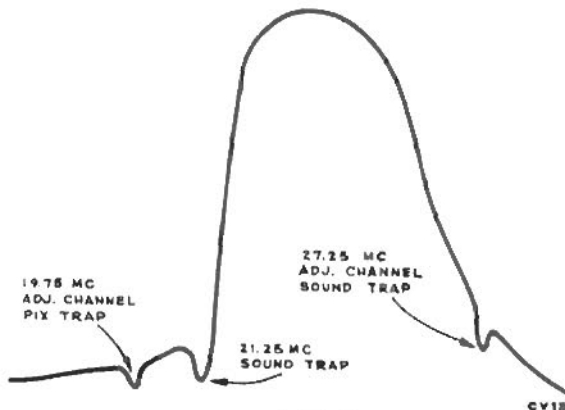


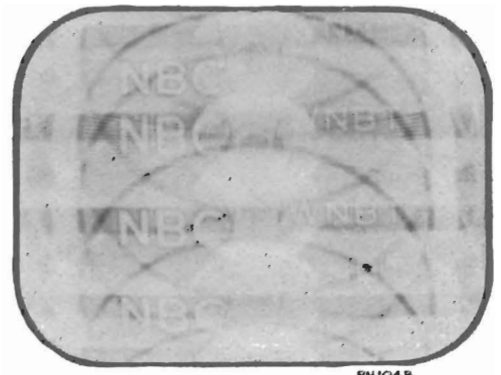
Figure 34—L185 Response

TEST PATTERN PHOTOGRAPHS

630TS



Figure 35—Normal Picture



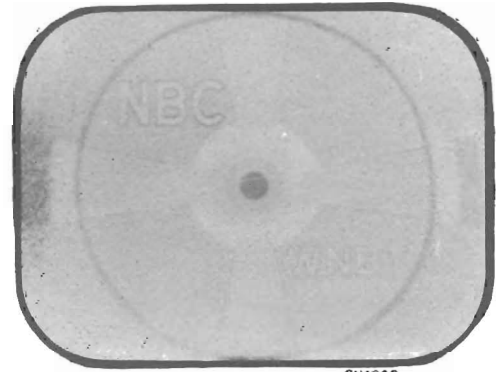
PH104B

Figure 36—Vertical Hold Control Misadjusted



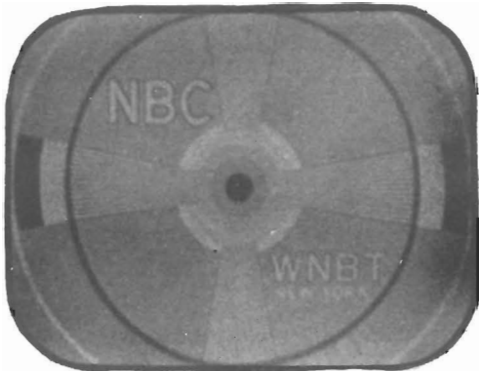
PH104C

Figure 37—Picture Control Misadjusted



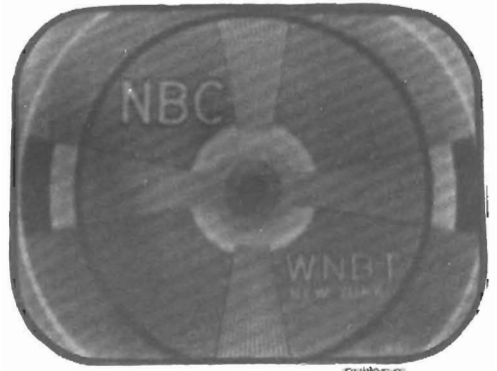
PH104D

Figure 38—Brightness Control Misadjusted



PH105A

Figure 39—Weak Signal



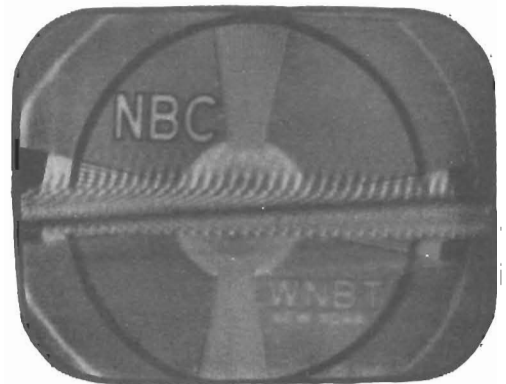
PH105B

Figure 40—Interference from Another Signal



PH105C

Figure 41—Sound in the Picture



PH105D

Figure 42—Interference, Diathermy, etc.



630TS

TEST PATTERN PHOTOGRAPHS

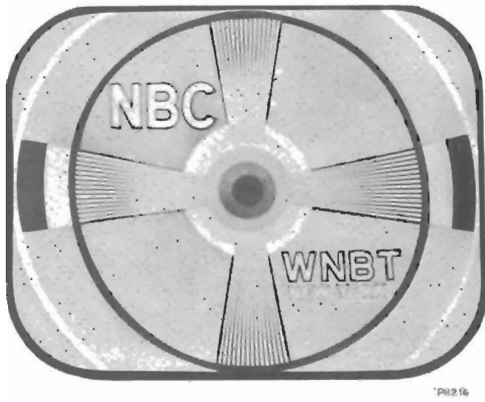


Figure 43—Normal Picture



Figure 44—Focus Coil and Ion Trap Magnet Misadjusted



Figure 45—Focus Control Misadjusted



Figure 46—Deflection Yoke Misadjusted (Rotated)

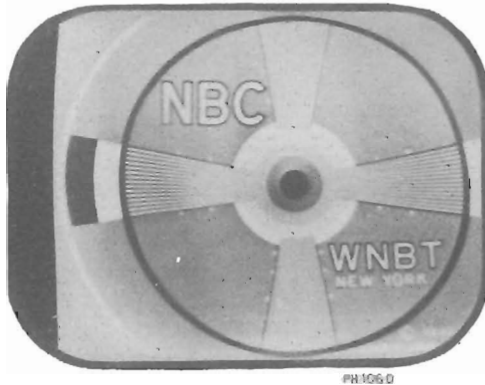


Figure 47—Horizontal Centering Control Misadjusted



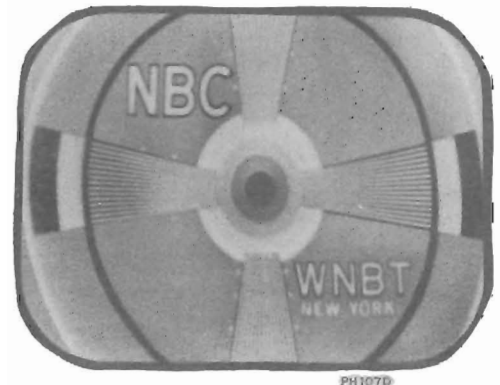
Figure 48—Vertical Centering Control Misadjusted



Figure 49—Vertical Linearity Control Misadjusted

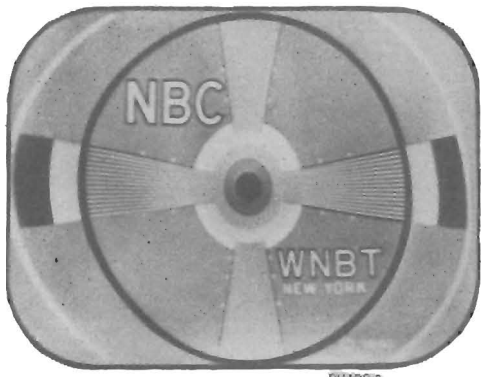


Figure 50—Height Control Misadjusted



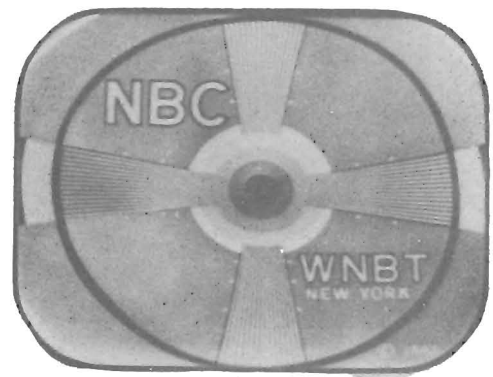
TEST PATTERN PHOTOGRAPHS

630TS



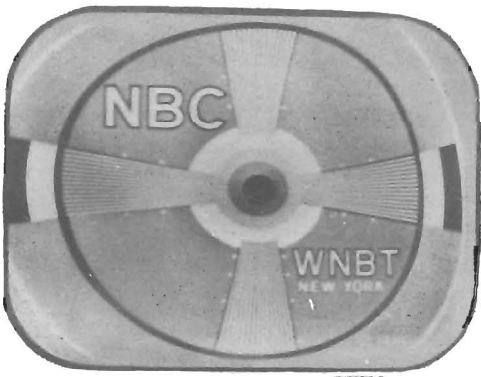
PH106A

Figure 51—Horizontal Linearity Control Misadjusted (Picture Cramped in Middle)



PH106B

Figure 52—Width Control Misadjusted



PH106C

Figure 53—Horizontal Drive Control Misadjusted



Figure 54—Hum in Video and Sync (Picture Off Center to Show Edge of Raster)



PH106D



PH107A

Figure 55—Reflections



Figure 56—Transients



PH107B

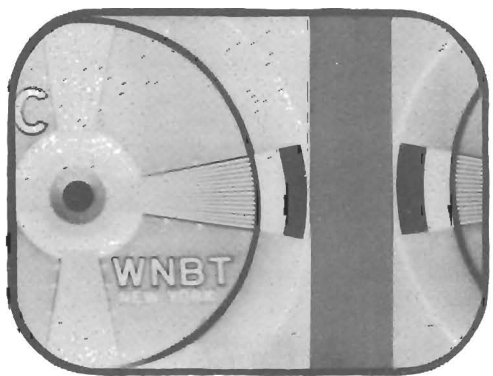


PH109C

Figure 57—Horizontal Sync Discriminator Transformer Frequency Adjustment Misadjusted



Figure 58—Horizontal Sync Discriminator Transformer Phase Adjustment Misadjusted

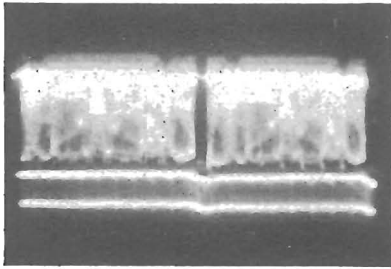


PH109D

WAVEFORM PHOTOGRAPHS

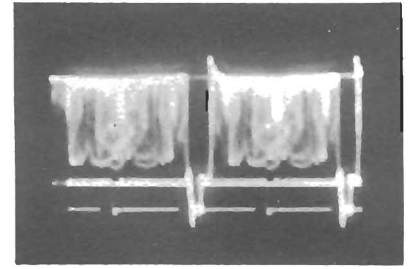
Video Signal Input to 1st Video Amplifier (Junction of L187, R136, L188 and C138)

Figure 59—Vertical (Oscilloscope Synced to $\frac{1}{2}$ of Vertical Sweep Rate) (1.5 Volts PP)



CV26A

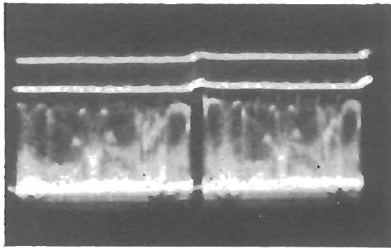
Figure 60—Horizontal (Oscilloscope Synced to $\frac{1}{2}$ of Horizontal Sweep Rate) (1.5 Volts PP)



CV26B

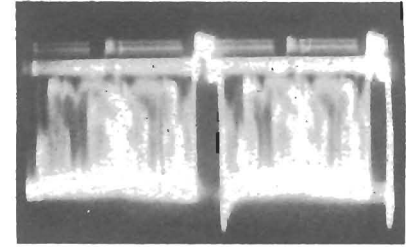
Output of 1st Video Amplifier (Junction of L189, R139, L190 and C140)

Figure 61—Vertical (10 Volts PP)



CV26C

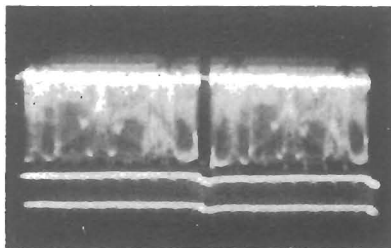
Figure 62—Horizontal (10 Volts PP)



CV26D

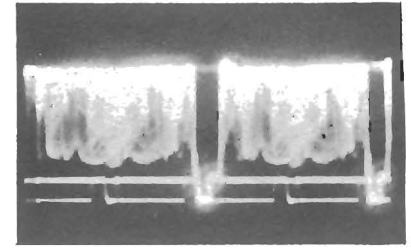
Input to Kinescope Grid (Junction of C141, R148 and Green Lead to Kinescope)

Figure 63—Vertical (38 Volts PP)



CV26E

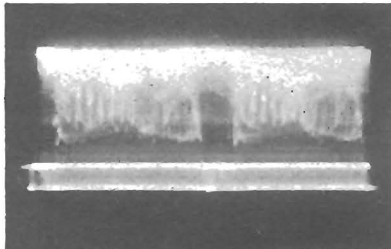
Figure 64—Horizontal (38 Volts PP)



CV26F

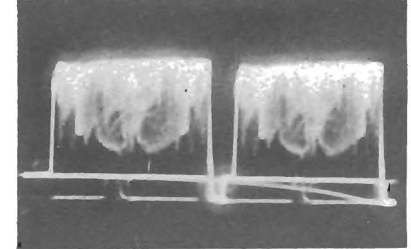
Cathode of D-C Restorer (Pin 5 of V114-B) (6AL5)

Figure 65—Vertical (36 Volts PP)



CV27A

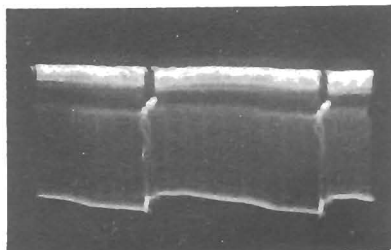
Figure 66—Horizontal (36 Volts PP)



CV27B

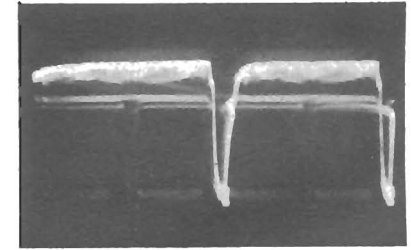
Plate of D-C Restorer (Pin 2 of V114-B) (6AL5)

Figure 67—Vertical (9 Volts PP)



CV27C

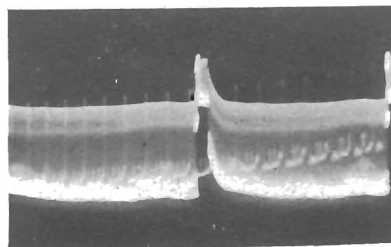
Figure 68—Horizontal (9 Volts PP)



CV27D

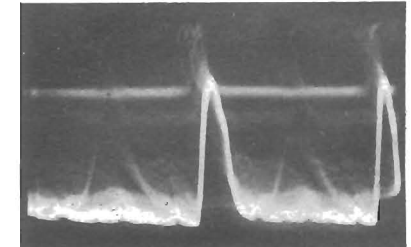
Output of 1st Sync. Amplifier (Pin 8 of V118) (6SK7)

Figure 69—Vertical (58 Volts PP)



CV27E

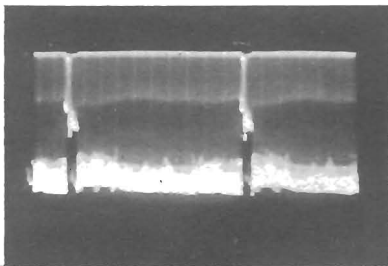
Figure 70—Horizontal (40 Volts PP)



CV27F

WAVEFORM PHOTOGRAPHS

630TS



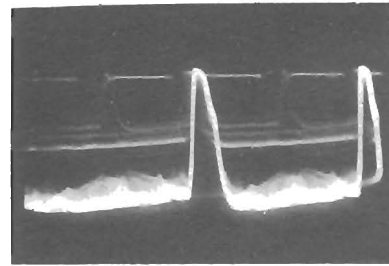
CV28A

Input to Sync. Separator (Pin 4 of V119) (6SH7)

Figure 71—Vertical (35 Volts PP)



Figure 72—Horizontal (35 Volts PP)



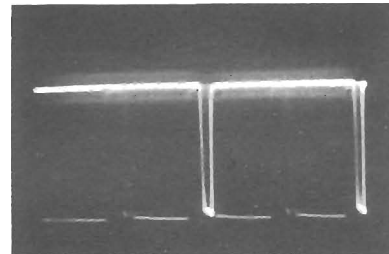
CV28B

Output of Sync. Separator (Pin 8 of V119) (6SH7)

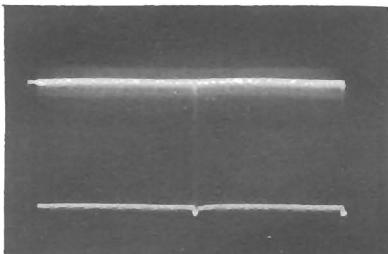
Figure 73—Vertical (75 Volts PP)



Figure 74—Horizontal (75 Volts PP)



CV28D



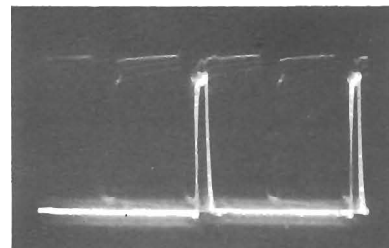
CV28C

Output of 2nd Sync. Amplifier (Pin 2 of V120-A) (6SN7GT)

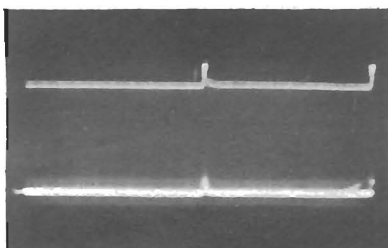
Figure 75—Vertical (35 Volts PP)



Figure 76—Horizontal (29 Volts PP)



CV28F



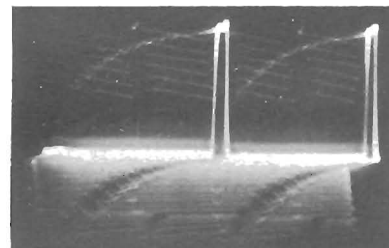
CV28E

Input to Integrating Network (Junction of C149, R162 and R163)

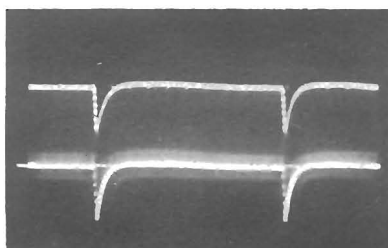
Figure 77—Vertical (45 Volts PP)



Figure 78—Horizontal (30 Volts PP)



CV29B

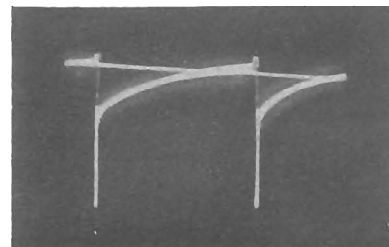


CV29A

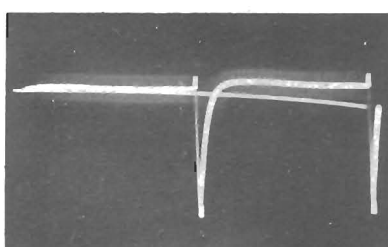
Figure 79—Output of Integrating Network (Junction of R165, C153 and Yellow Lead of T106). Vertical (32 Volts PP)



Figure 80—Grid of Vertical Osc. (350 Volts PP) (Pin 5 of V121) (6J5)



CV29D

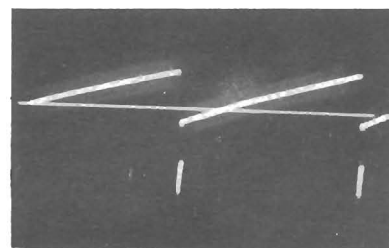


CV29C

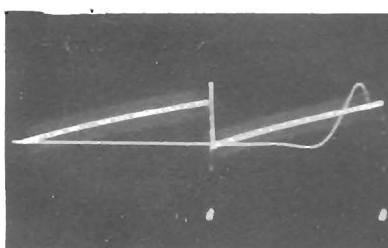
Figure 81—Plate of Vertical Osc. (140 Volts PP) (Pin 3 of V121) (6J5)



Figure 82—Input Coupling of Vertical Output (125 Volts PP) (Junction of C157, C158, R170 and Red Lead of T106)

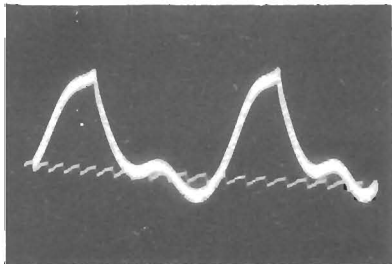


CV29F



CV29E

WAVEFORM PHOTOGRAPHS

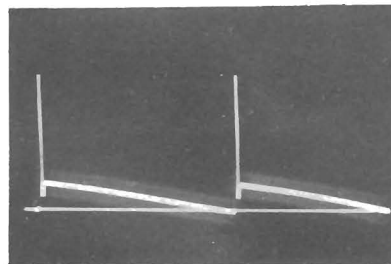


CV30A

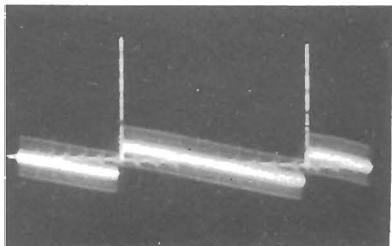
Figure 83—Cathode of Vertical Output (.75 Volt PP) (Pin 8 of V122) (6K6GT)



Figure 84—Plate of Vertical Output (700 Volts PP) (Pin 3 of V122) (6K6GT)



CV30B

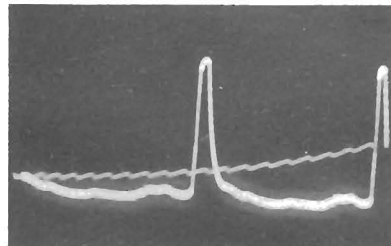


CV30C

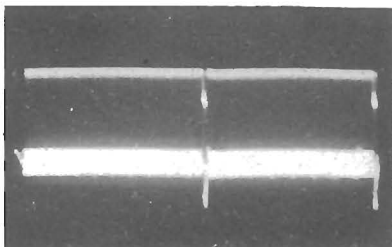
Figure 85—Input to Vertical Deflection Coils (60 Volts PP) (Junction of Green Lead of T107 and Green Lead of Yoke)



Figure 86—Vertical Boost of 1st Sync. Amplifier (16 Volts PP) (Junction of R154, R155 and C146)



CV30D



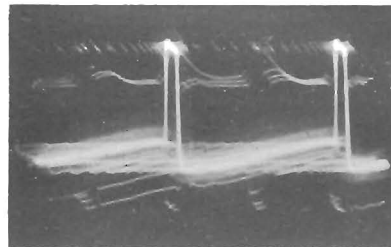
CV31A

Terminal "E" of Sync Discriminator Transformer (T108)

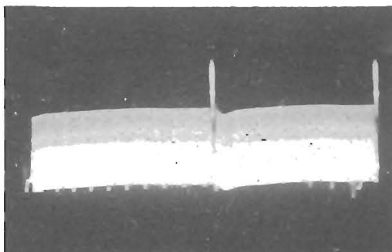
Figure 87—Vertical (16 Volts PP)



Figure 88—Horizontal (13 Volts PP)



CV31B



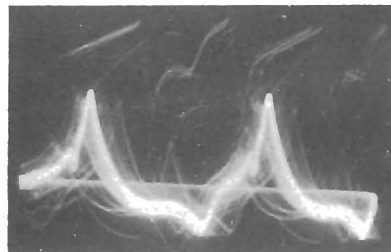
CV31C

Junction of R191 and R192 (Cathode Resistors of Horizontal Sync. Discriminator)

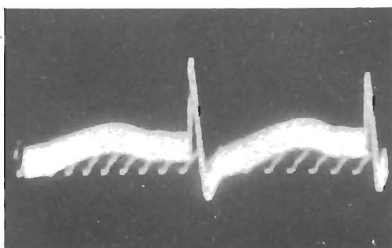
Figure 89—Vertical (3 Volts PP)



Figure 90—Horizontal (1.7 Volts PP)



CV31D



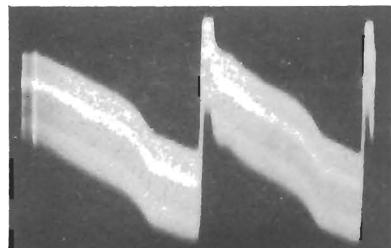
CV31E

Cathode of Hor. Sync. Discriminator (Pin 1 of V123) (6AL5)

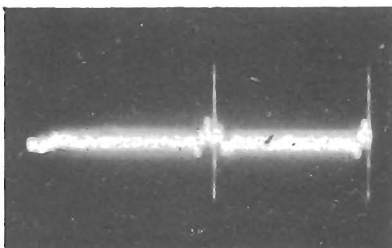
Figure 91—Vertical (.8 Volt PP)



Figure 92—Horizontal (.15 Volt PP)



CV31F

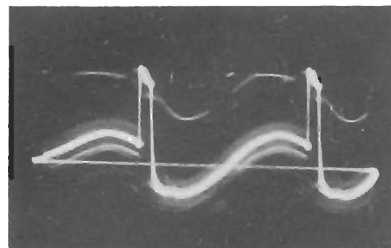


CV32A

Figure 93—Cathode of Hor. Sync. Discr. (Pin 5 of V123) (6AL5) Horizontal (.19 Volt PP)



Figure 94—Plate of Hor. Sync. Discr. (Pin 7 of V123) (6AL5) Horizontal (23 Volts PP)



CV32C

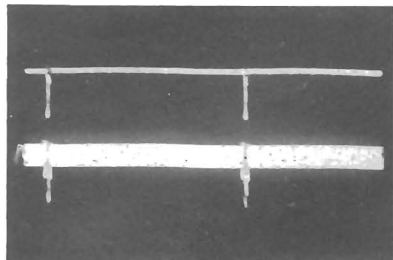


Plate of Hor. Sync. Discr. (Pin 2 of V123) (6AL5)

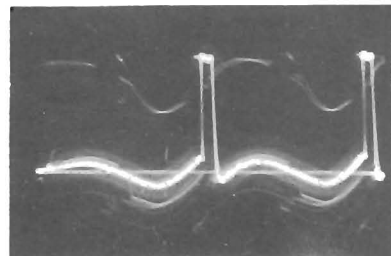
Figure 95—Vertical (21 Volts PP)



Figure 96—Horizontal (21 Volts PP)



CV32D



V32E

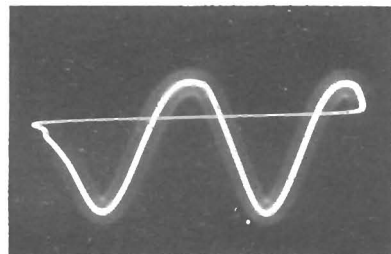
Figure 97—Horizontal (95 Volts PP) Terminal "A" of Sync. Discriminator Transformer (T108)



Figure 98—Cathode of Horizontal Oscillator Control (1.5 Volts PP) (Pin 5 of V124) (6AC7)



CV33A



CV33B

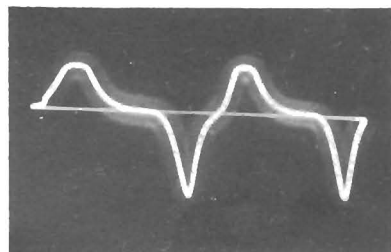
Figure 99—Plate of Horizontal Oscillator (225 Volts PP) (Pin 3 of V125) (6K6GT)



Figure 100—Input of Hor. Discharge (100 Volts PP) (Junction of C176, C177 and R202)



CV33C



CV33D

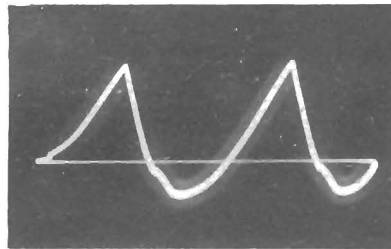
Figure 101—Plate of Hor. Discharge (78 Volts PP) (Pin 5 of V120-B) (6SN7GT)



Figure 102—Cathode of Hor. Output (11.5 Volts PP) (Pin 3 of V126) (6BG6-G)



CV33E



CV33F

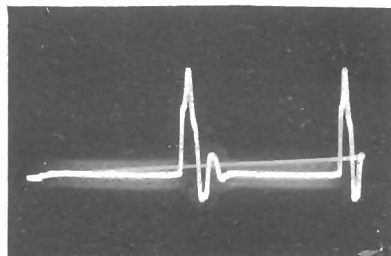
Figure 103—Screen of Hor. Output (9 Volts PP) (Pin 8 of V126) (6BG6-G)



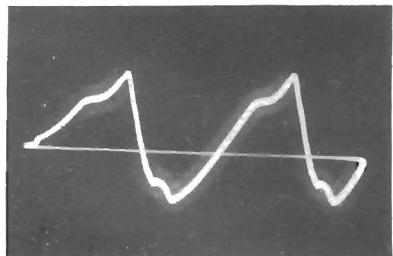
Figure 104—Plate of Horizontal Output (Approx. 6000 Volts PP) (Measured Through a Capacity Voltage Divider Connected from Top Cap of V126 to Ground)



CV34A



CV34B

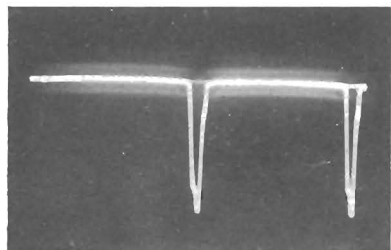


CV34C

Figure 105—Cathode of Reaction Scanning (60 Volts PP) (Pin 8 of V128) (5V4G)



Figure 106—Input to Horizontal Deflection Coils (1325 Volts PP) (Pin 4 of V128) (5V4G)



CV34E

VOLTAGE CHART

Measurements made with receiver operating on 117 volts 60 cycles a-c and with no signal input except where otherwise indicated. Voltages shown are as read with Jr. VoltOhmyst between indicated terminal and chassis ground except where otherwise noted. Symbol < means "less than."

Tube No.	Tube Type	Function	Operating Condition **	E. Plate		E. Screen		E. Cathode		E. Grid		I Plate (ma.)	I Screen (ma.)	Notes on Measurements
				Pin No.	Volts	Pin No.	Volts	Pin No.	Volts	Pin No.	Volts			
V1	6J6	R-F Amplifier	Pictr. Min.	1 & 2	130	—	—	7	0	5 & 6	-9.2	<.1*	—	*Per Plate
			Pictr. Max.	1 & 2	55	—	—	7	0	5 & 6	+0.5	7.0*	—	*Per Plate
V2	6J6	Converter	Pictr. Min.	1 & 2	125	—	—	7	0	5 & 6	-3 to -6.	.5 to 4*	—	*Per Plate
			Pictr. Max.	1 & 2	100	—	—	7	0	5 & 6	-2 to -5.	.2 to 3*	—	*Per Plate
V3	6J6	R-F Oscillator	Pictr. Min.	1 & 2	108	—	—	7	.25	5 & 6	-4.5 to -6.5	2.5	—	
			Pictr. Max.	1 & 2	90	—	—	7	.15	5 & 6	-3.5 to -5.	1.7	—	
V104	6BA6	1st Sound I-F Amplifier	Pictr. Min.	5	120	6	120	7	1.9	1	0	12.0	5.0	
			Pictr. Max.	5	110	6	110	7	1.6	1	0	10.5	4.5	
V105	6BA6	2d Sound I-F Amplifier	Pictr. Min.	5	122	6	118	7	1.9	1	0	12.5	4.9	
			Pictr. Max.	5	113	6	108	7	1.6	1	0	10.5	4.2	
V106	6AU6	3d Sound I-F Amplifier	Pictr. Min.	5	48	6	48	7	0	1	-5	3.3	1.4	
			Pictr. Max.	5	41	6	41	7	0	1	-5	2.8	1.2	
V107	6AL5	Sound Discrim.	Pictr. Min.	2 & 7	-35	—	—	4 & 5	—	—	—	—	—	
			Pictr. Max.	2 & 7	-45	—	—	4 & 5	—	—	—	—	—	—
V108	6AT6	1st Audio Amplifier	Pictr. Min.	7	80	—	—	2	0	1	-7.5	.5	—	
V109	6K6-GT	Audio Output	Pictr. Min.	3	253	4	265	8	0	5	-18	27.5	4.0	
V110	6AG5	1st Pix. I-F Amplifier	Pictr. Min.	5	135	6	135	2 & 7	0	1	-5.0	<.1	<.1	
			Pictr. Max.	5	109	6	109	2 & 7	.26	1	-1.0	5.5	.9	
V111	6AG5	2d Pix. I-F Amplifier	Pictr. Min.	5	135	6	135	2 & 7	0	1	-5.0	<.1	<.1	
			Pictr. Max.	5	113	6	113	2 & 7	.26	1	-1.0	5.6	.9	
V112	6AG5	3d Pix. I-F Amplifier	Pictr. Min.	5	135	6	135	2 & 7	0	1	-5.0	<.1	<.1	
			Pictr. Max.	5	98	6	117	2 & 7	.26	1	-1.0	5.7	.9	
V113	6AG5	4th Pix. I-F Amplifier	Pictr. Min.	5	99	6	127	2 & 7	1.2	1	0	6.8	1.7	
			Pictr. Max.	5	89	6	117	2 & 7	1.1	1	0	6.8	1.7	
V114-A	6AL5	Picture 2d Det.	Pictr. Min.	7	-1	—	—	1	0	—	—	—	—	
V114-B	6AL5	DC Restorer	Brightness Min.	2	-100	—	—	5	-90	—	—	—	—	
			Brightness Max.	2	-1	—	—	5	-9	—	—	—	—	—
V115	6AU6	1st Video Amplifier	Pictr. Min.	5	240	6	135	7	0	1	-2.15	4.0	1.55	
			Pictr. Max.	5	255	6	125	7	0	1	-2.2	2.8	1.05	
V116	6K6-GT	2d Video Amplifier	Pictr. Min.	3	105	4	135	8	3.7	5	-7.5	9.6	1.6	
			Pictr. Max.	3	95	4	125	8	2.9	5	-7.5	7.5	1.3	

** Where separate readings are not listed for max. and min. gain settings of the picture control, the effect of the control is slight and readings are given for "Picture Min."

VOLTAGE CHART

630TS

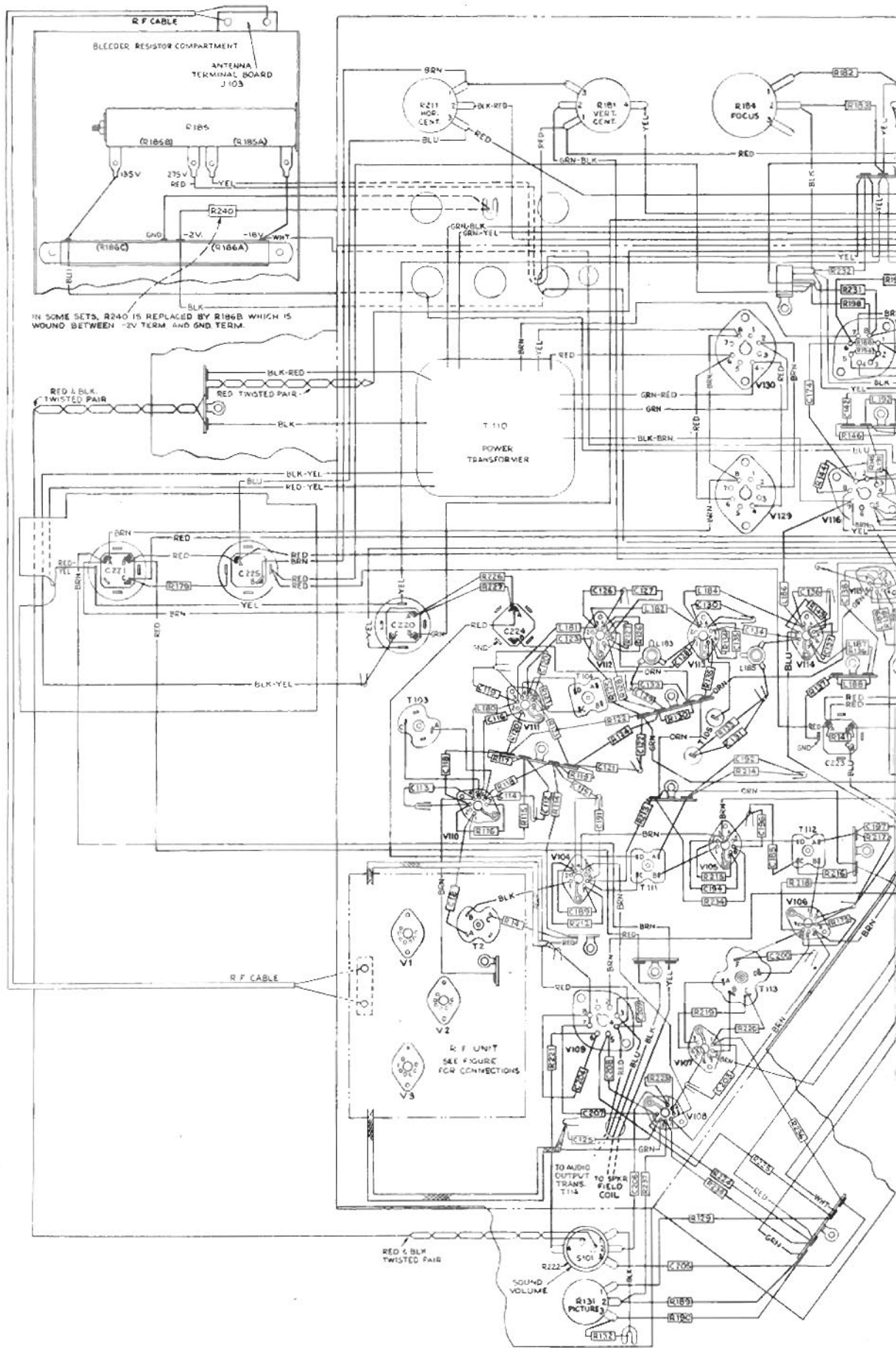
Tube No.	Tube Type	Function	Operating Condition**	E. Plate		E. Screen		E. Cathode		E. Grid		I Plate (ma.)	I Screen (ma.)	Notes on Measurements
				Pin No.	Volts	Pin No.	Volts	Pin No.	Volts	Pin No.	Volts			
V117	10-BP4	Kinescope	Brightness Min.	Cap	9200*	10	275	11	0	2	-100	0	0	*Measured with VoltOhmyst and high voltage multiplier probe
			Brightness Max.	Cap	6000*	10	275	11	0	2	0	.7	—	
			Brightness Average	Cap	9000*	10	275	—	—	—	—	.05	—	
V118	6SK7	1st Sync. Amplifier	Pictr. Min.	8	163	6	129	5	0	4	-4.3	11.5	3.8	
			Pictr. Max.	8	185	6	115	5	0	4	-4.4	9.2	2.9	
V119	6SH7	Sync. Separator	Pictr. Min.	8	134	6	135	5	0	4	-5.2	.1	.05	
			Pictr. Max.	8	123	6	125	5	0	4	-9*	.3	.1	*Depends on noise
V120-A	6SN7 GT	2d Sync. Amplifier	Pictr. Min.	2	88	—	—	3	0	1	-5	9.0	—	
			Pictr. Max.	2	80	—	—	3	0	1	-9*	7.9	—	*Depends on noise
V120-B	6SN7 GT	Horizontal Discharge	Pictr. Min.	5	-37	—	—	6	-100	4	-140	.5	—	
V121	6J5	Vertical Oscillator	Pictr. Min.	3	70*	—	—	8	-100	5	-150	.15	—	*Height, linearity and hold affect readings 2 to 1
V122	6K6-GT	Vertical Output	Pictr. Min.	3	180	4	180*	8	-70	5	-100	9.0	*	*Screen connected to plate
V123	6AL5	Horizontal Sync. Discr.	Pictr. Min.	2 & 7	-6.5	—	—	1 & 5	-2.1	—	—	—	—	
V124	6AC7	Horizontal Osc. Control	Pictr. Min.	8	194	6	105	5	.05	4	-2.0	3.8	1.1	
V125	6K6-GT	Horizontal Oscillator	Hold Max. Resistance	3	190	4	208	8	0	5	-30	17.0	6.7	
			Hold Min. Resistance	3	180	4	194	8	0	5	-23.5	19.5	8.2	
V126	6BG6-G	Horizontal Output	Pictr. Min.	Cap	Do not Meas.*	8	134	3	-95	5	-113	77.0	11.5	* 6000 volt pulse present
V127	8016	H. V. Rectifier	Brightness Min.	Cap	*	—	—	2 & 7	9200	—	—	0	—	*9200 volt pulse present
			Brightness Max.	Cap	*	—	—	2 & 7	6700	—	—	.7	—	*9200 volt pulse present
V128	5V4G	Reaction Scanning	Pictr. Min.	4 & 6	Do not Meas.*	—	—	8	350	—	—	90	—	* 1200 volt pulse present
V129	5U4G	Rectifier	Pictr. Min.	4 & 6	390*	—	—	2 & 8	300	—	—	146	—	*A-C measured from plate to trans center tap
V130	5U4G	Rectifier	Pictr. Min.	4 & 6	390*	—	—	2 & 8	300	—	—	146	—	

** Where separate readings are not listed for max. and min. gain settings of the picture control, the effect of the control is slight and readings are given for "Picture Min."

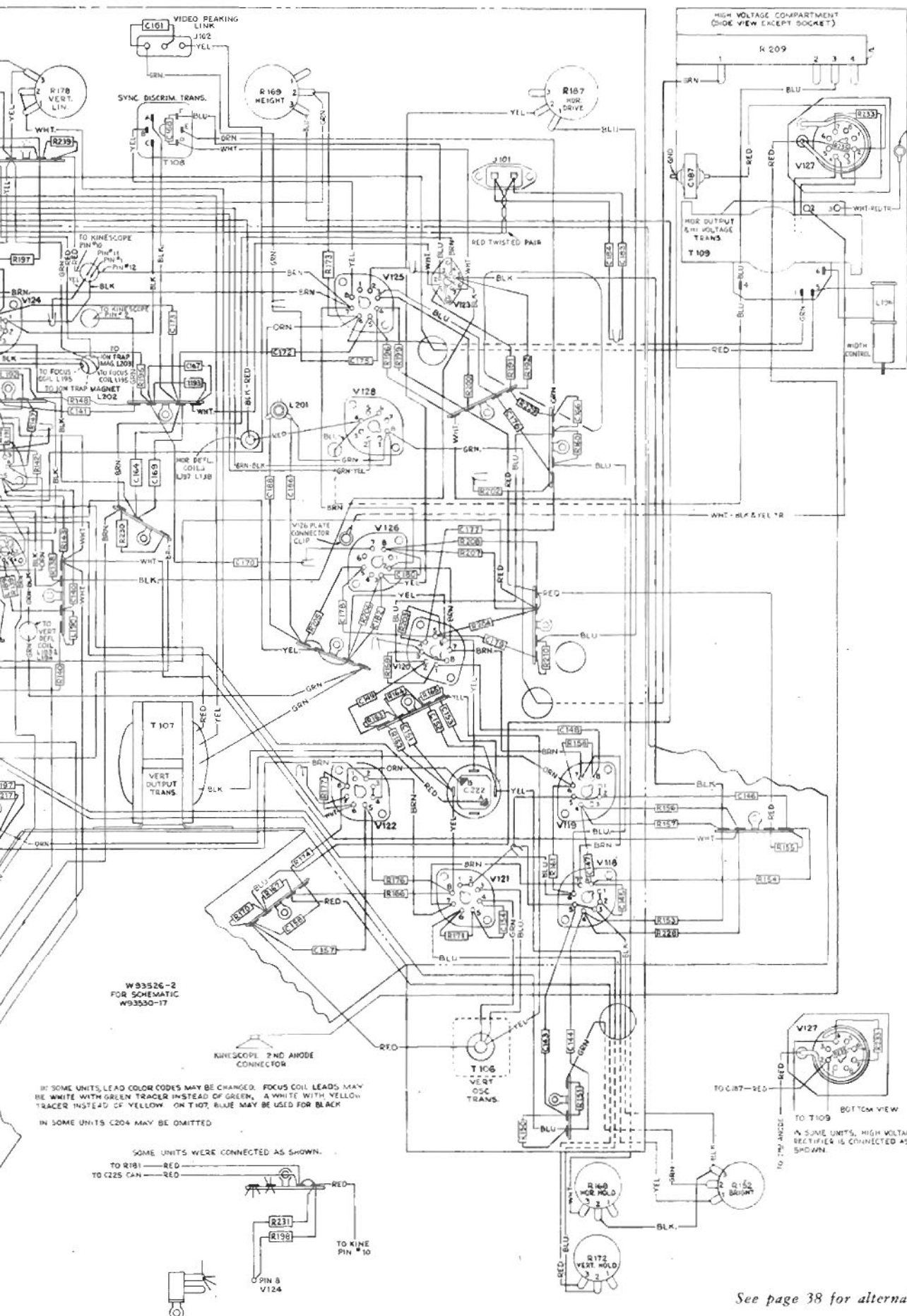
Following readings taken with video signal applied through video amplifiers to produce 25 volts peaks to peak on Kinescope grid.

V114-B	6AL5	DC Restorer	Pictr. Min.	2	-41	—	—	5	-27	—	—	—	—	
V119	6SH7	Sync. Separator	Pictr. Min.	8	136	6	142	5	0	4	-21.5	.9	.8	
V120-A	6SN-7GT	2d Sync. Amplifier	Pictr. Min.	2	88	—	—	3	0	1	-5.4	9.0	—	
V123	6AL5	Horizontal Sync. Discr.	Pictr. Min.	2 & 7	-20	—	—	1 & 5	K ₁ * K ₂ -2.1	—	—	—	—	*See grid voltage of V124
V124	6AC7	Horizontal Osc. Control	Pull-in*	8	200 ^(a)	6	100 ^(b)	5	<.1	4	-1.5 to -3	<.8	<2.5	*Varying Hor. Osc. tuning
			Hold*	8	200 ^(c)	6	100 ^(d)	5	<.1	4	(e)	<.8	<2.5	

- (a) Pull-in range varies with tubes from 110-210 to 195-270.
 (b) Pull-in range varies with tubes from 80-100 to 100-115.
 (c) Hold range varies with tubes from 110-270 to 140-270.
 (d) Hold range varies with tubes from 80-115 to 90-115.
 (e) Hold range varies with tubes from 1.5-7.0 to 1-4.5.



WIRING DIAGRAM



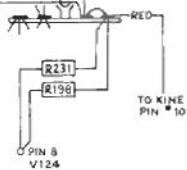
W93526-2
FOR SCHEMATIC
W93530-17

IN SOME UNITS, LEAD COLOR CODES MAY BE CHANGED. FOCUS COIL LEADS MAY BE WHITE WITH GREEN TRACER INSTEAD OF GREEN, A WHITE WITH YELLOW TRACER INSTEAD OF YELLOW. ON T107, BLUE MAY BE USED FOR BLACK.

IN SOME UNITS, C204 MAY BE OMITTED.

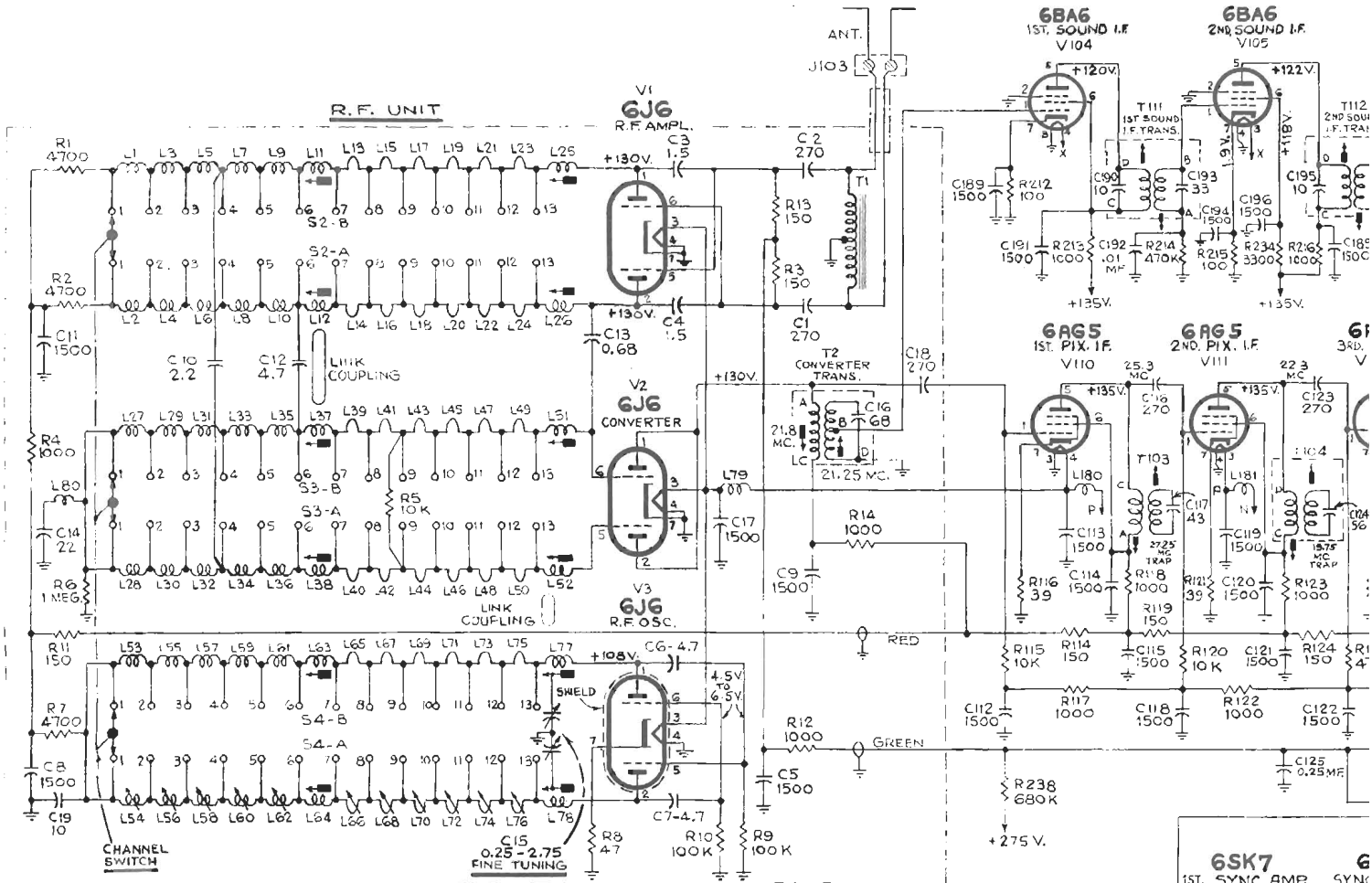
SOME UNITS WERE CONNECTED AS SHOWN.

TO R181 - RED
TO C225 CAN - RED



TO T109
TO 6-3V RECTIFIER
IN SOME UNITS, HIGH VOLTAGE RECTIFIER IS CONNECTED AS SHOWN.

See page 38 for alternate wiring of J102



K = 1000

All resistance values in ohms, and capacitance values in mmfd., unless otherwise noted.

Direction of arrows at controls indicates clockwise rotation.

All voltages measured with Volt-Ohmyst and with picture control counterclockwise. Voltages should hold within $\pm 20\%$ with 117 v. a-c supply.

The schematic diagram shows the circuit with all the latest changes incorporated at the time of printing.

In some receivers C19 is omitted.

In some receivers C14 is fixed.

In some receivers R239 is omitted.

In some receivers C164 is omitted.

In some receivers R177 is 27K.

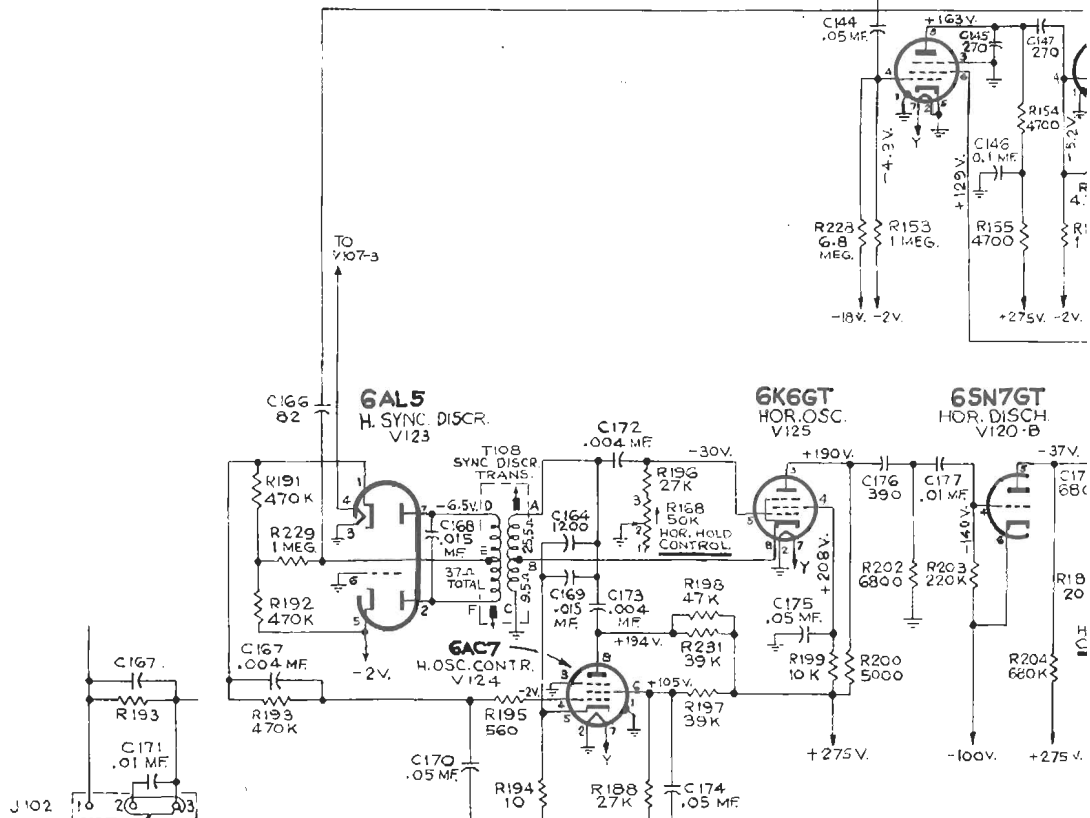
In early production receivers, R186B is employed in place of R240.

In receivers with a sup. 4 power transformer, R208 is 27K.

In some receivers L187 is 180 Mu. H and R'36 is 39K.

In some receivers the terminals 1 and 3 of the link, J102, are connected across R193 and a .01 mf. capacitor (C171) is connected between terminals 2 and 3.

In some receivers, substitutions have caused changes in component lead color codes, in electrolytic capacitor values and their lug identification markings.



NOTE: LINK CONN. TO
1-2 UNSTABLE SYNC. POS.
2-3 NORMAL POSITION OF LINK.
J102: CONNECTION IN SOME RECEIVERS.

REPLACEMENT PARTS

630TS

STOCK NO.	DESCRIPTION	STOCK NO.	DESCRIPTION
	R.F. UNIT ASSEMBLY		TELEVISION CHASSIS ASSEMBLIES KCS 20A-1
71504	Capacitor--Ceramic, 0.08 mmf. (C13)	71894	Bearing--Bearing for r-f unit shaft
71500	Capacitor--Ceramic, 1.5 mmf. (C3, C4)	71460	Board--"Antenna" terminal board (J103)
71502	Capacitor--Ceramic, 2.2 mmf. (C10)	71454	Board--Sync Link terminal board, 3 terminals with link (J102)
71520	Capacitor--Ceramic, 4.7 mmf. (C6, C7, C12)	71524	Cable--R-F cable (from r-f unit to J103)
45466	Capacitor--Ceramic, 10 mmf. (C19)	71532	Cap--Hi-voltage rectifier and horizontal output plate cap
33101	Capacitor--Ceramic, 22 mmf. (C14)	39604	Capacitor--Mica, 10 mmf. (C137)
65401	Capacitor--Mica, 270 mmf. (C18)	71771	Capacitor--Ceramic, 51 mmf. (C197)
71540	Capacitor--Ceramic, 270 mmf. (C1, C2)	73090	Capacitor--Mica, 82 mmf., 1000 volts (C166)
71501	Capacitor--Ceramic, 1500 mmf. (C5, C8, C9, C11, C17)	71514	Capacitor--Ceramic, 82 mmf. (C131)
72122	Coil--Channel #1 front and rear converter grid coil and channel #1 front and rear r-f amplifier plate coil (L1, L2, L27, L28)	73091	Capacitor--Mica, 270 mmf., 1000 volts (C116, C123, C128, C134, C145, C147, C203)
71469	Coil--Channel #1 front or rear osc. coil (L53, L54)	39642	Capacitor--Mica, 390 mmf. (C176)
71480	Coil--Channels #4 front and rear r-f amplifier plate coils (L7, L8)	39644	Capacitor--Mica, 470 mmf. (C161), in some receivers
71470	Coil--Channel #2 front, channel #3 front and channel #4 front oscillator coil (L56, L58, L60)	71450	Capacitor--Hi-voltage filter, 500 mmf. (C187)
71479	Coil--Channel #2 front and rear, channel #4 front and rear converter grid coils, channel #2 front and rear, channel #3 front and rear r-f amplifier plate coils (L3, L4, L5, L6, L29, L30, L33, L34)	39648	Capacitor--Mica, 680 mmf. (C179)
72597	Coil--Channel #3 front and rear converter grid coils (L31, L32)	72638	Capacitor--Ceramic, 1200 mmf. (C164), in some receivers
72552	Coil--Channel #3 rear oscillator coil (L57)	71501	Capacitor--Ceramic, 1500 mmf. (C112, C113, C114, C115, C118, C119, C120, C121, C122, C126, C127, C129, C130, C133, C135, C136, C185, C189, C191, C194, C196)
72553	Coil--Channel #4 rear oscillator coil (L59)	39668	Capacitor--Mica, 4700 mmf. (C154)
71472	Coil--Channel #5 rear oscillator coil (L61)	71690	Capacitor--Ceramic, 6500 mmf. (C200)
71481	Coil--Channel #5 front and rear converter grid coils, channel #5 front and rear r-f amplifier coils (L9, L10, L35, L36)	70642	Capacitor--Tubular, .001 mfd., 1000 volts (C178)
71471	Coil--Channel #5 front, and channel #2 rear oscillator coil (L55, L62)	70601	Capacitor--Tubular, .002 mfd., 400 volts (C151)
71492	Coil--Channel #6 front and rear oscillator, converter grid and r-f amplifier plate coils (L11, L12, L37, L38, L63, L64)	70602	Capacitor--Tubular, .0025 mfd., 400 volts (C205, C207)
71488	Coil--Channel #13 front oscillator coil (L78)	70605	Capacitor--Tubular, .004 mfd., 400 volts (C172)
71489	Coil--Channel #13 rear oscillator coil (L77)	70647	Capacitor--Tubular, .004 mfd., 1000 volts (C167, C173)
71490	Coil--Channel #13 front converter grid and r-f amplifier plate coil (L26, L52)	70606	Capacitor--Tubular, .005 mfd., 400 volts (C152, C153, C208)
71491	Coil--Channel #13 rear converter grid and r-f amplifier plate coil (L25, L51)	70627	Capacitor--Tubular, .005 mfd., 600 volts (C209)
71506	Coil--Converter grid trap coil (L80)	70610	Capacitor--Tubular, .01 mfd., 400 volts (C149, C171, C177, C192, C204, C206)
71505	Coil--Heater choke coil (L79)	71770	Capacitor--Moulded paper, .01 mfd., 400 volts (C183, C184)
71493	Connector--Segment connector	71516	Capacitor--Tubular, impregnated, .015 mfd., 400 volts (C168, C169)
71497	Core--Channel #6 oscillator coil adjustable core	73100	Capacitor--Tubular, impregnated, .035 mfd., 1000 volts (C188)
71498	Core--Channels #6 and #13 converter grid and r-f amplifier coils adjustable core	71515	Capacitor--Tubular, impregnated, .05 mfd., 600 volts (C158)
71597	Core--Channel #13 oscillator coils adjustable core	73093	Capacitor--Tubular, impregnated, .05 mfd., 1000 volts (C186)
71463	Detent--R-F unit detent mechanism and fiber shaft	70615	Capacitor--Tubular, .05 mfd., 400 volts (C138, C144, C148, C170, C180)
71465	Disc--Rotor disc for fine tuning control (Part of C15)	70636	Capacitor--Tubular, .05 mfd., 600 volts (C140, C141, C142, C174, C175)
71464	Drive--Fine tuning pinch washer drive	70617	Capacitor--Tubular, 0.1 mfd., 400 volts (C157, C182)
71487	Form--Coil form only for channels #6 and #13 coils--less winding	70638	Capacitor--Tubular, .1 mfd., 600 volts (C146)
71462	Loop--Oscillator to converter grid coupling loop	70618	Capacitor--Tubular, 0.25 mfd., 400 volts (C125, C143)
30732	Resistor--47 ohms, 1/2 watt (R8)	71435	Capacitor--Electrolytic, comprising 20 mfd., 450 volts and 80 mfd., 350 volts (C224a, C224b)
30880	Resistor--150 ohms, 1/2 watt (R3, R11, R13)	71434	Capacitor--Electrolytic, comprising 40 mfd., 450 volts; 10 mfd., 450 volts and 10 mfd., 350 volts (C223a, C223b, C223c)
34766	Resistor--1000 ohms, 1/2 watt (R4, R12, R14)	71431	Capacitor--Electrolytic, comprising 40 mfd., 450 volts; 10 mfd., 450 volts and 80 mfd., 150 volts (C220a, C220b, C220c)
30494	Resistor--4700 ohms, 1/2 watt (R1, R2, R7)	71432	Capacitor--Electrolytic, comprising 40 mfd., 450 volts; 40 mfd., 450 volts and 10 mfd., 450 volts (C221a, C221b, C221c)
3078	Resistor--10,000 ohms, 1/2 watt (R5)	71433	Capacitor--Electrolytic, comprising 80 mfd., 450 volts and 50 mfd., 50 volts (C222a, C222b)
3252	Resistor--100,000 ohms, 1/2 watt (R9, R10)	71436	Capacitor--Electrolytic, comprising 250 mfd., 10 volts and 1000 mfd., 6 volts (C225a, C225b)
30652	Resistor--1 megohm, 1/2 watt (R6)	71426	Coil--Third or fourth picture if coil (L183, L185)
14343	Ring--Retainer ring for drive	71505	Coil--Choke coil (L180, L181, L182, L184, L186)
71475	Screw--#4-40 x .296 adjusting screw for coils L54, L55, L59, L60, L62	71421	Coil--Focus coil (L195)
71476	Screw--#4-40 x 1/4" binder head screw for adjusting coils L66, L68, L70, L72, L74, L76	71449	Coil--Horizontal linearity control coil (L201)
71473	Segment--Converter grid and r-f amplifier plate front section's segment less coils (Part of S2, S3)	71527	Coil--Peaking coil, 90 mu. h. (L190, L192)
71474	Segment--Converter grid and r-f amplifier plate section's segment less coils (Part of S2, S3)	71529	Coil--Peaking coil, 120 mu. h. (L187, L189, L191, R136, R139, R145)
71467	Segment--Oscillator section front segment less coils (Part of S4)	71526	Coil--Peaking coil, 250 mu. h. (L188)
71468	Segment--Oscillator section rear segment less coils (Part of S4)	71429	Coil--Width control coil (L196)
72951	Shield--Lead tube shield for V3	71523	Connector--Kinescope anode connector
71494	Socket--Tube socket, miniature	71521	Connector--Hi-voltage capacitor connector
71461	Spring--Snap spring to hold fine tuning shaft	71444	Control--Brightness control (R152)
71466	Stator--Oscillator fine tuning stator and bushing (Part of C15)		
71507	Transformer--Antenna transformer (T1)		
71495	Transformer--Converter transformer (T2, C16)		

